

GT

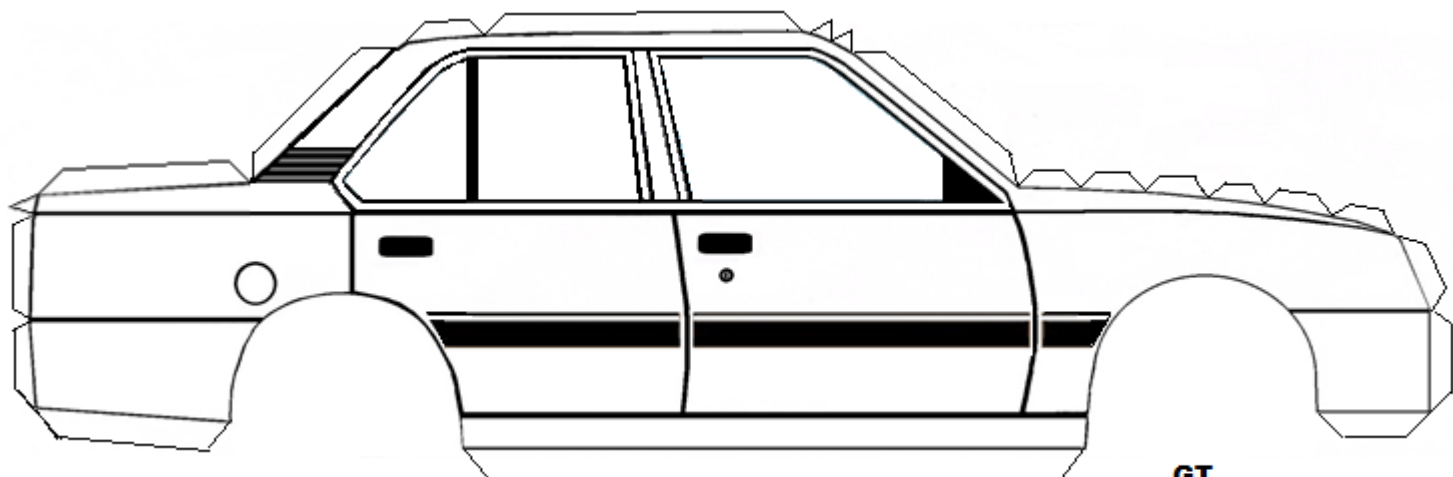

GT

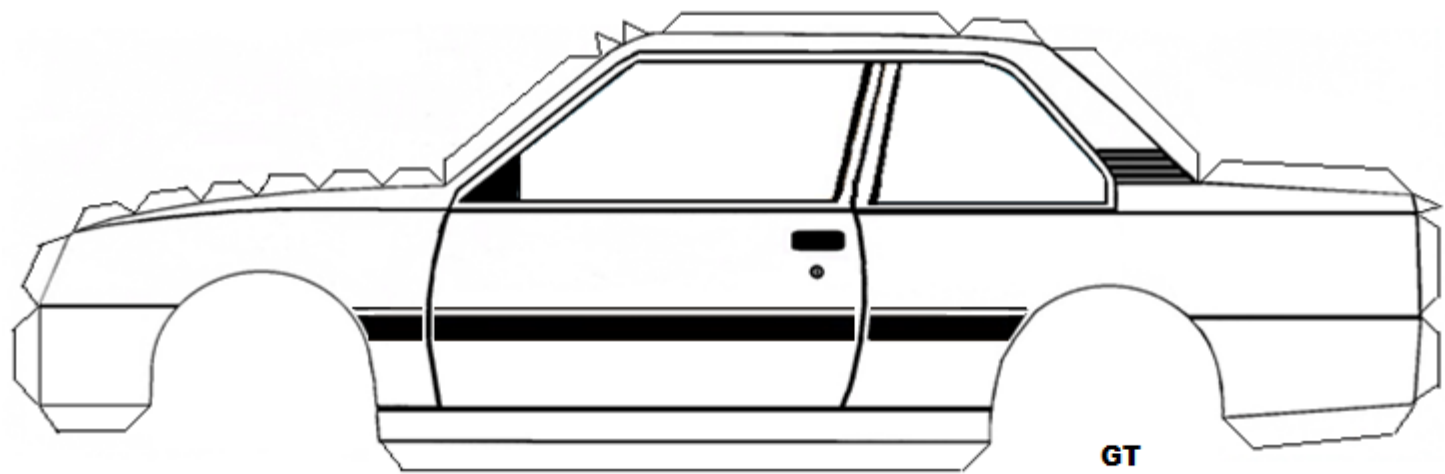

GT

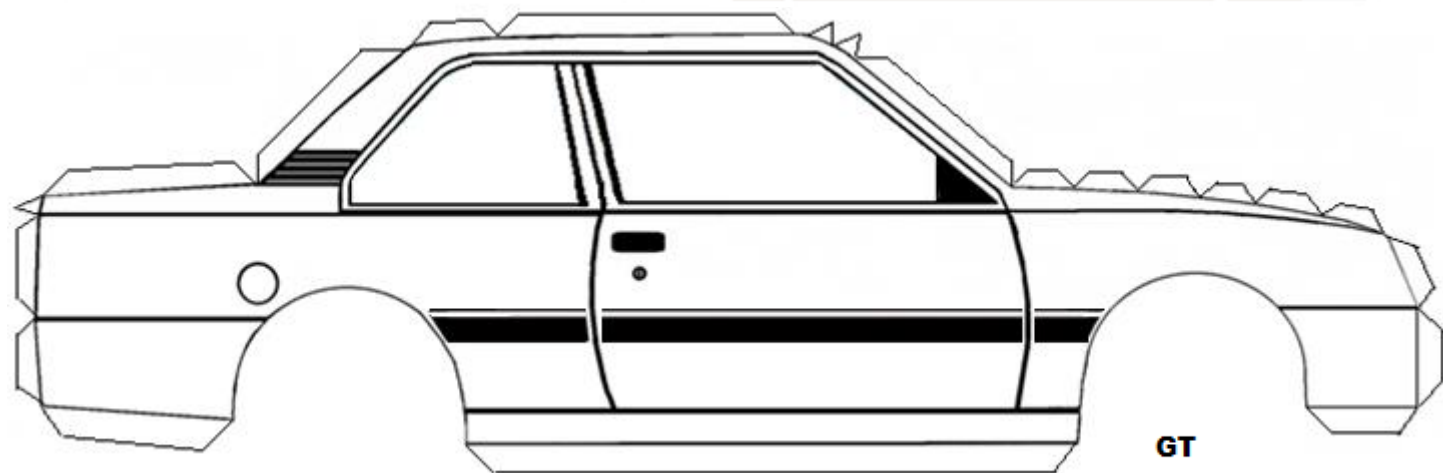

GT



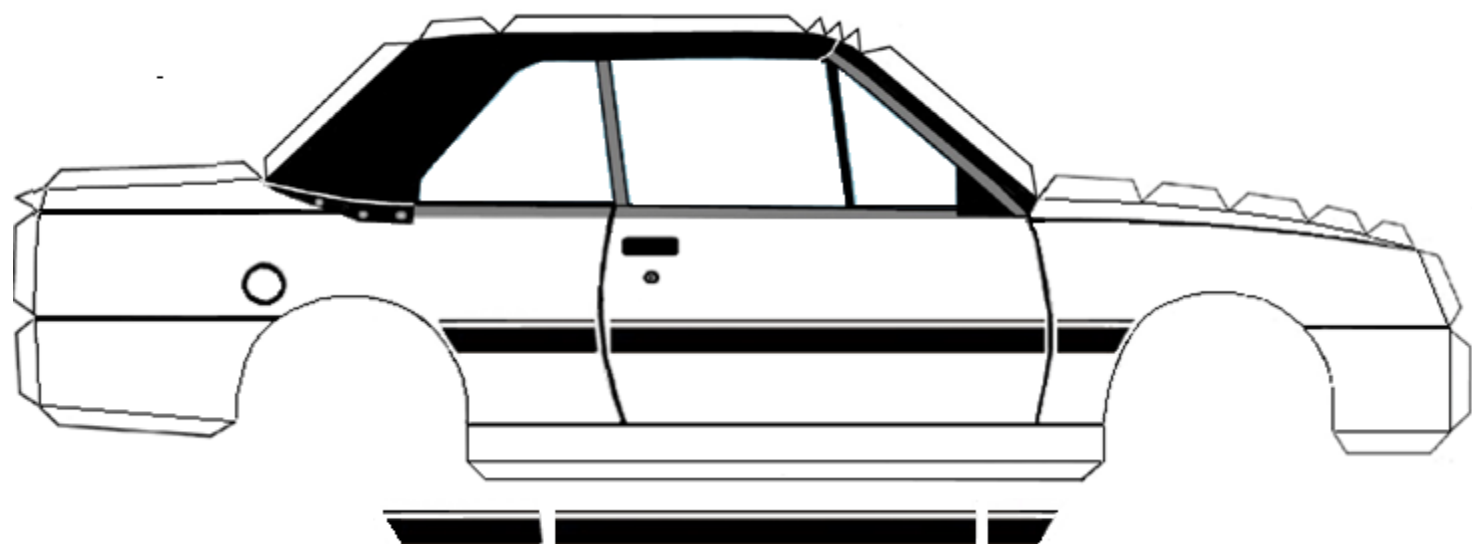
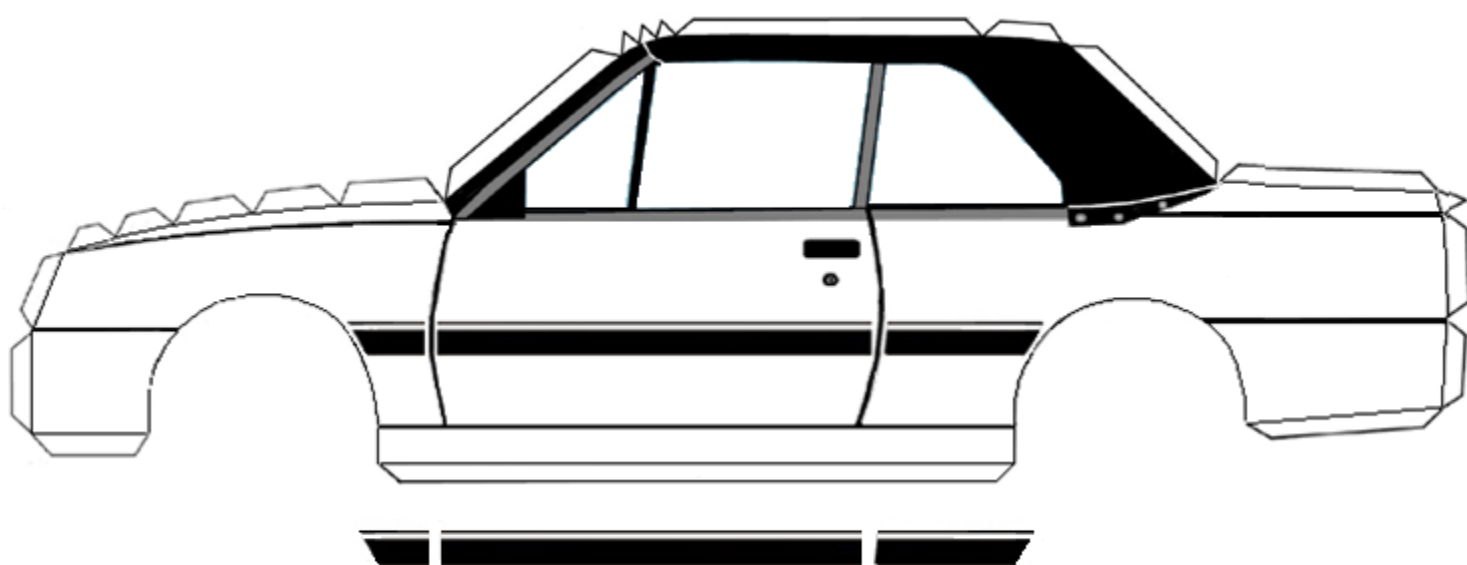
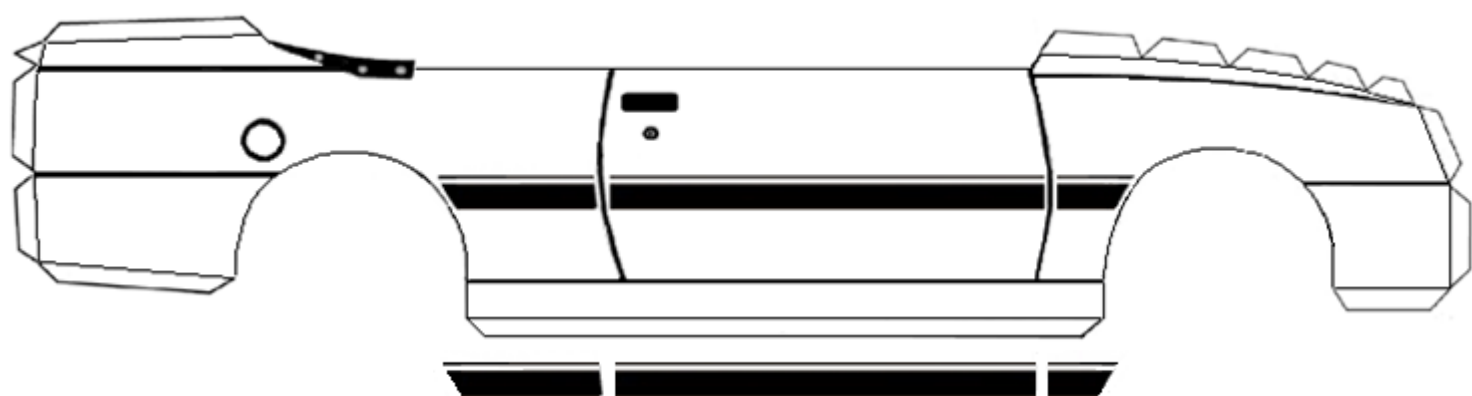
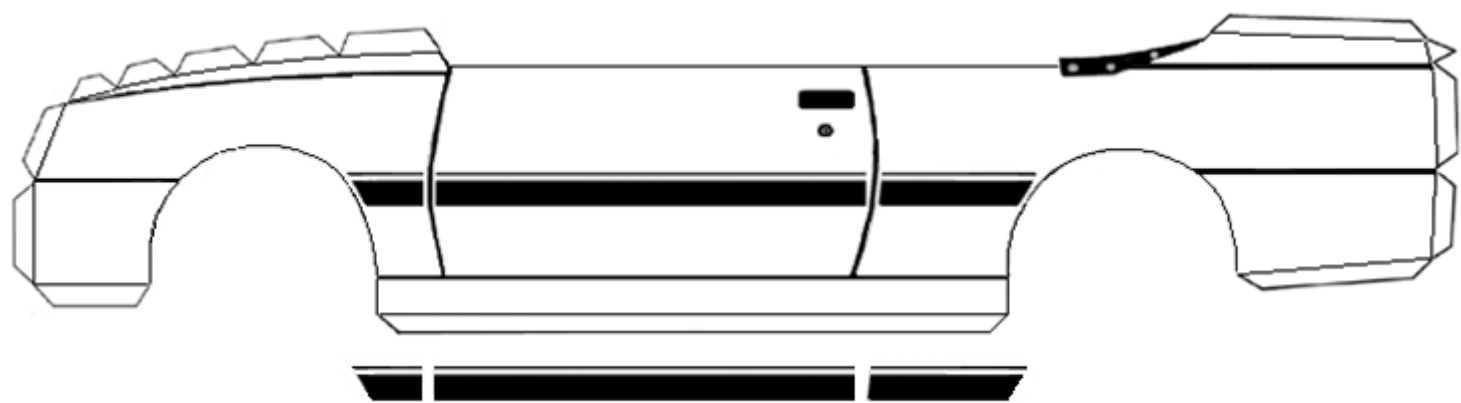

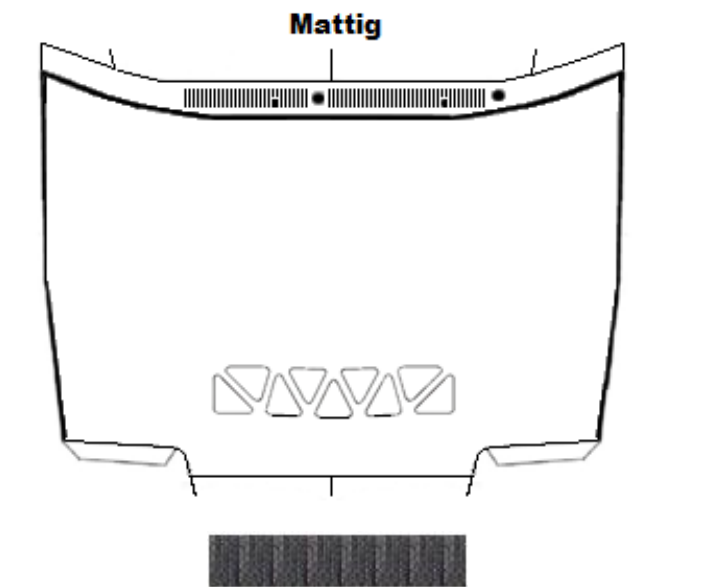
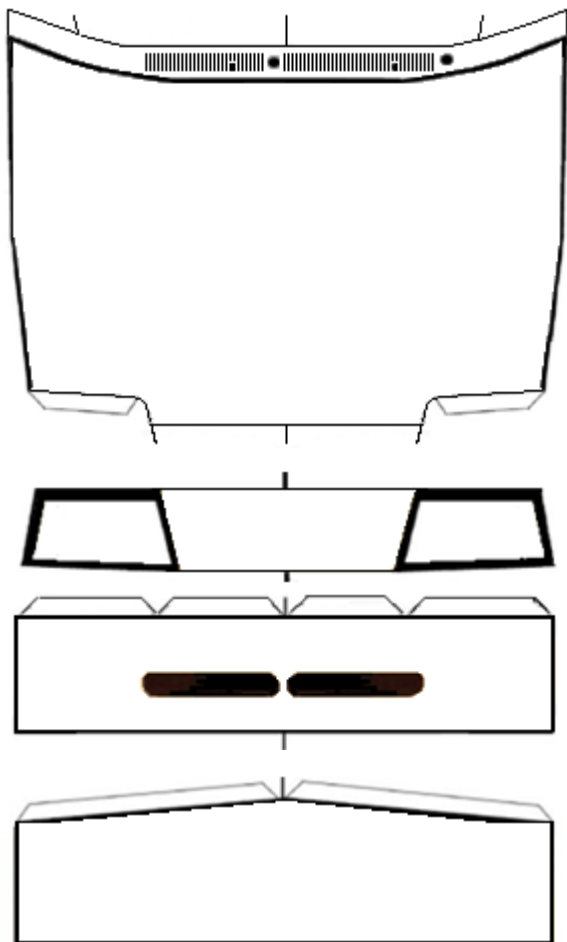
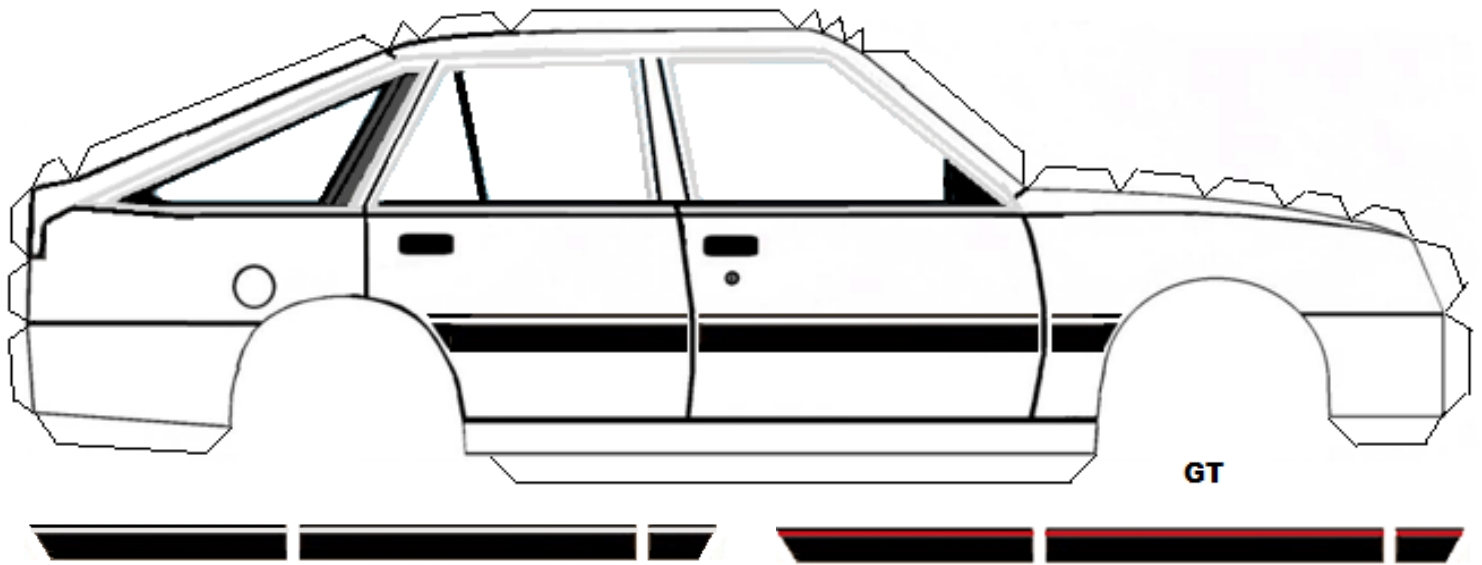
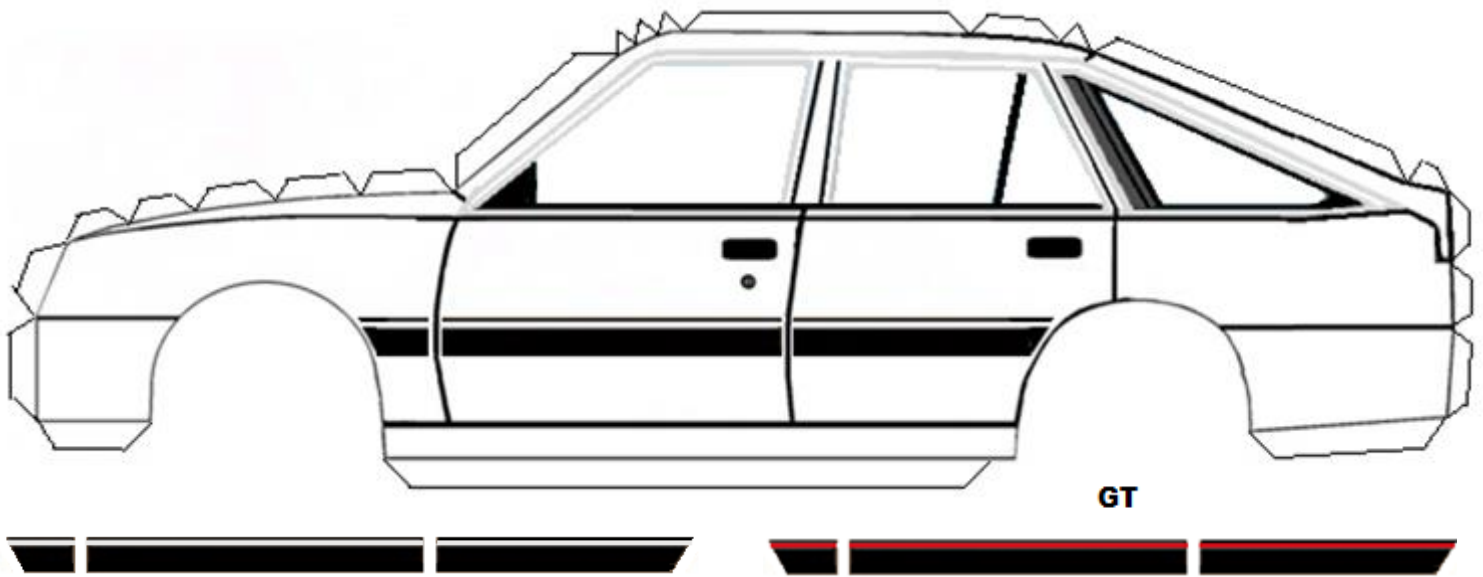

Beschriftung

- | | | | | | |
|-------|-----------|---------------|-----|-----------------|----|
| LUXUS | LS | GL | GLS | GLS
EXKLUSIV | CD |
| LUXUS | LS | GL | GLS | GLS
EXKLUSIV | CD |
| | <i>GT</i> | <i>ASCONA</i> | | <i>OPEL</i> | |
| | <i>GT</i> | | | | |

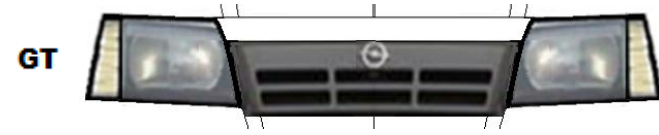
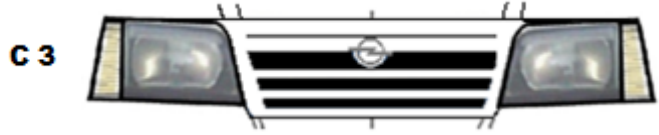
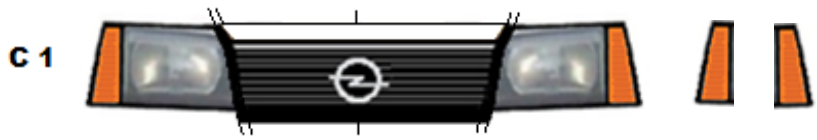

Irmscher 1



Mattig

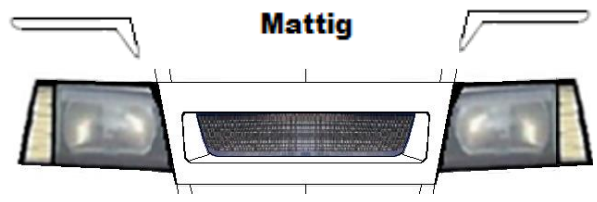

C 1

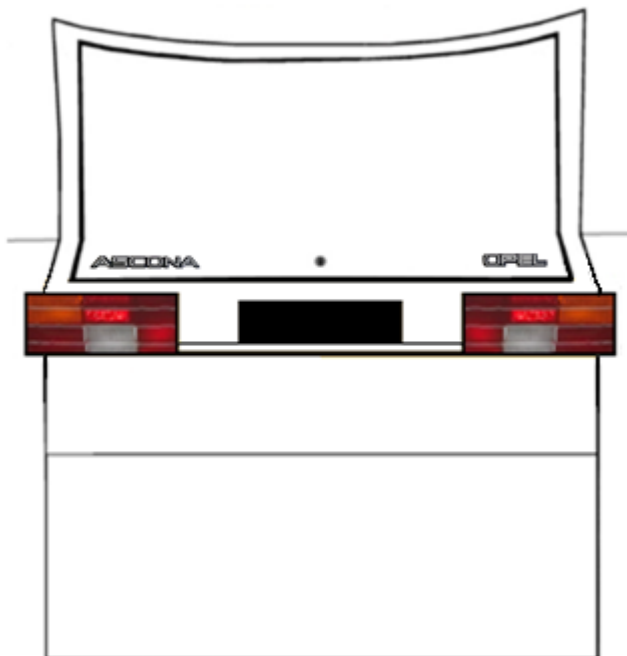

C 2/3

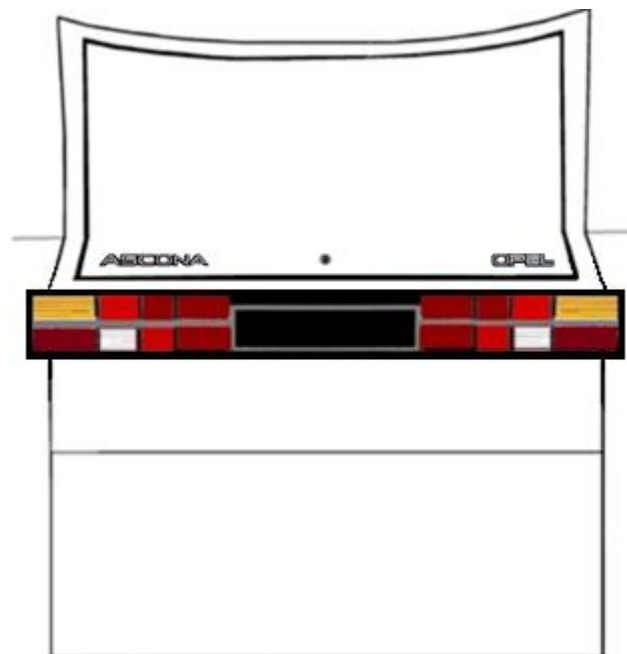

C 1
CC



C 2/3
CC

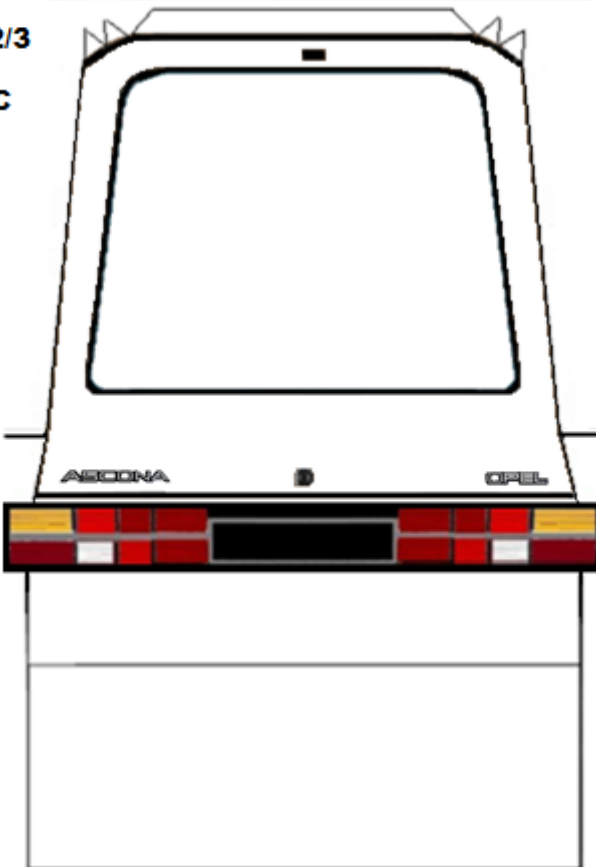

Scheibenwischer vorne



Scheibenwischer hinten CC



Spiegel



Auspuff

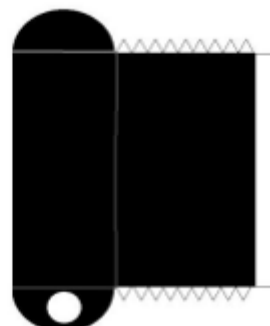

Schmutzfänger



ABCDEFGHI
 JKLMNOPQRS
 TUVWXYZÄÖÜ
 0123456789
 ☼ ☼ ☼ ☼ ☼ ☼ ☼ ☼

2/4 Türer

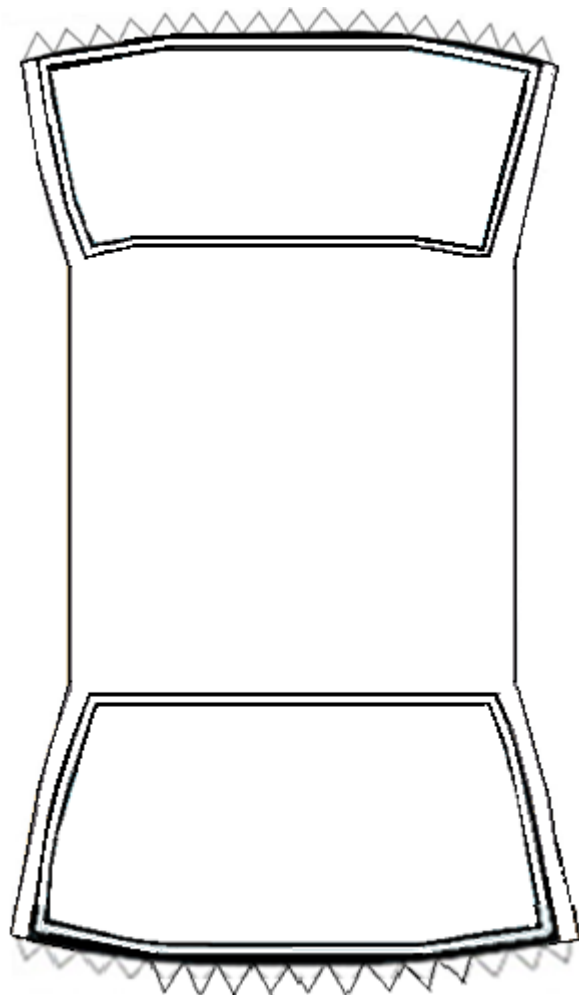

CC

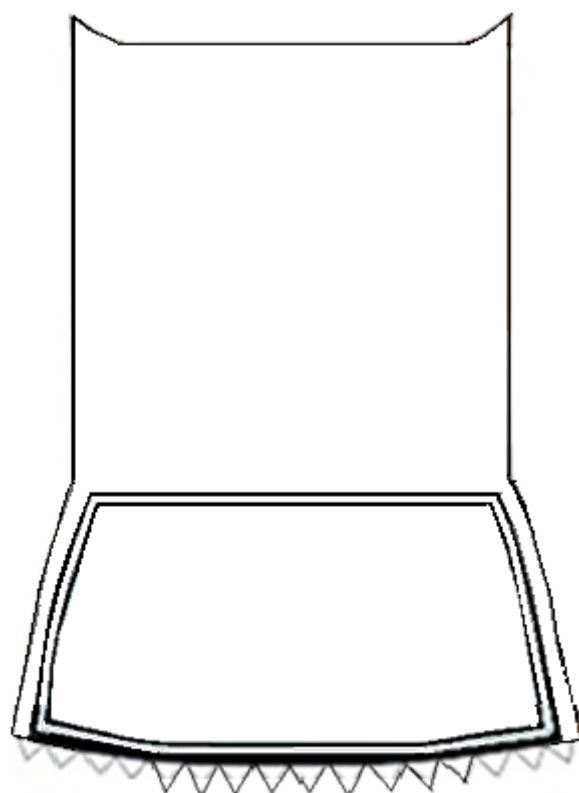

Cabrio geschlossen

Aussenseite

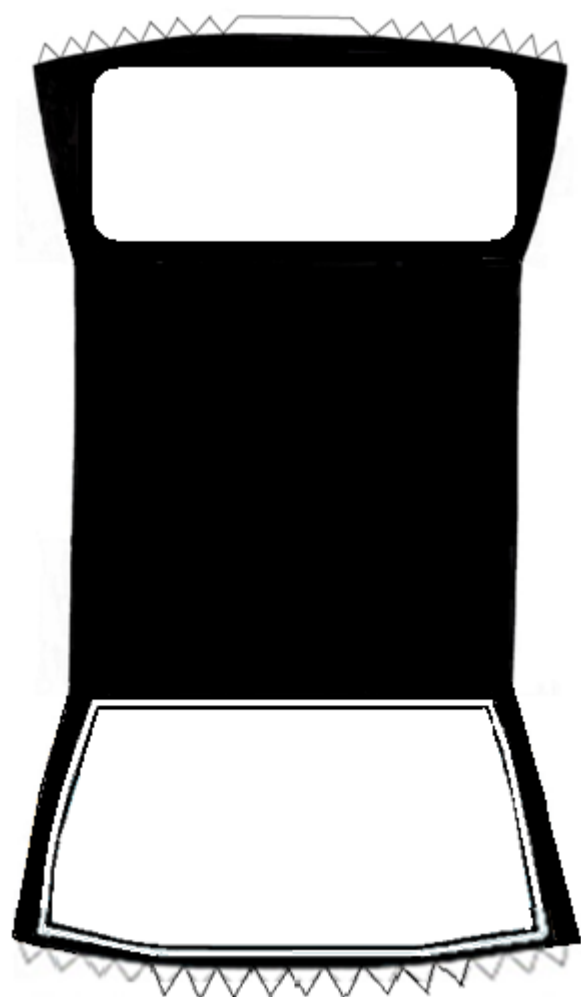

Innenseite

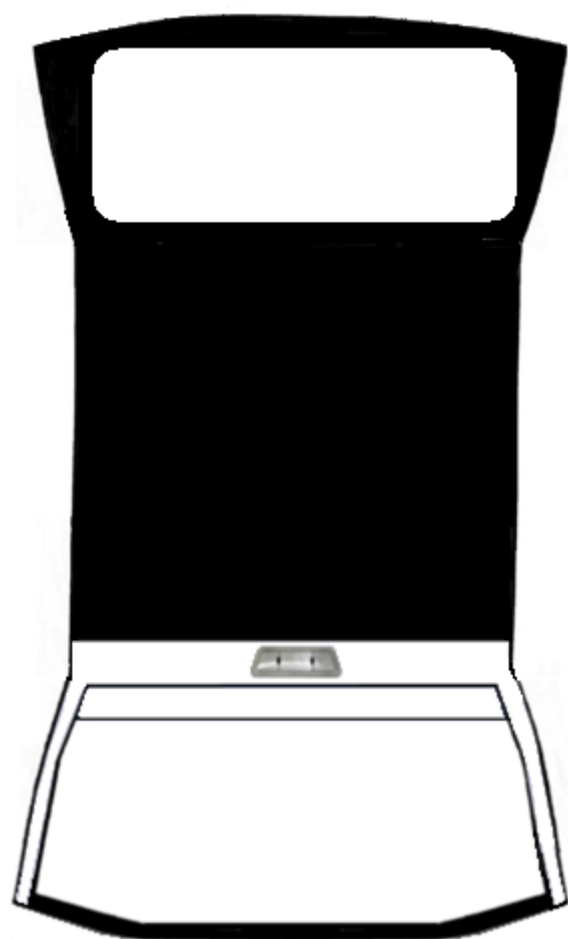

Cabrio offen

Aussenseite

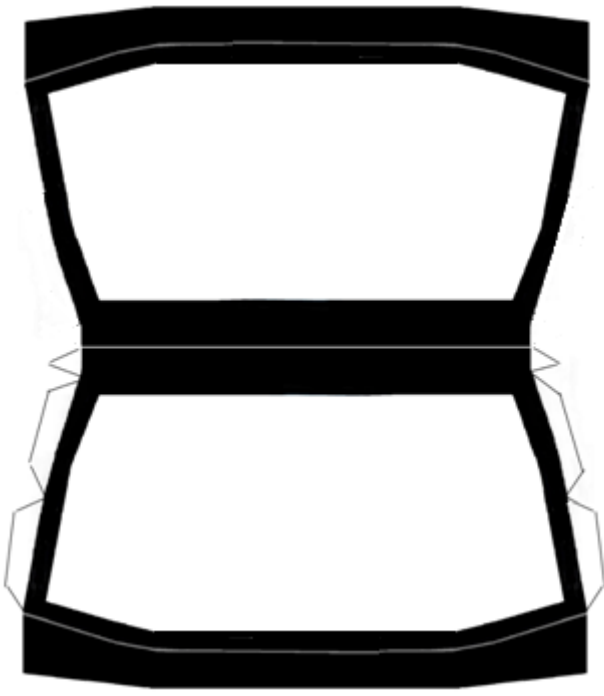

Innenseite

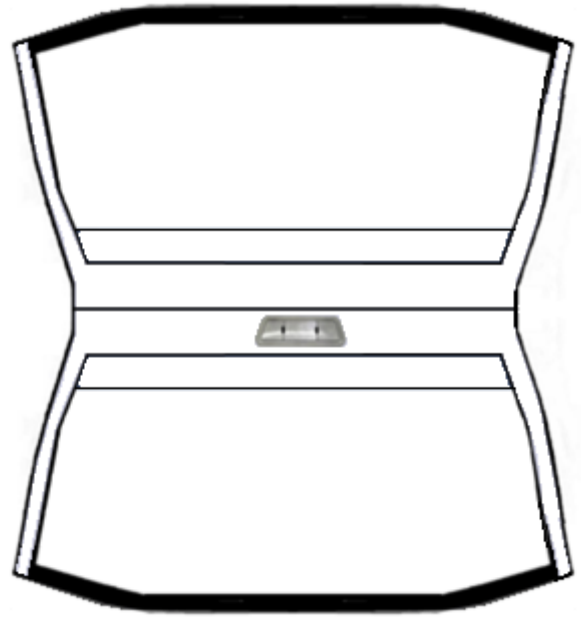

Feste Folie

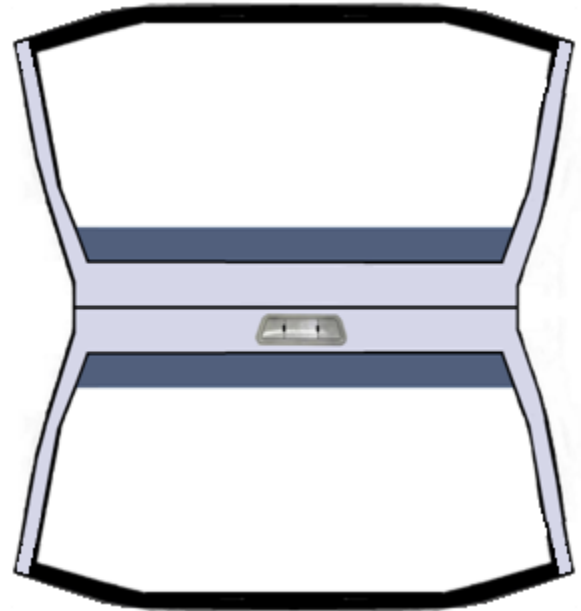

Aussenseite

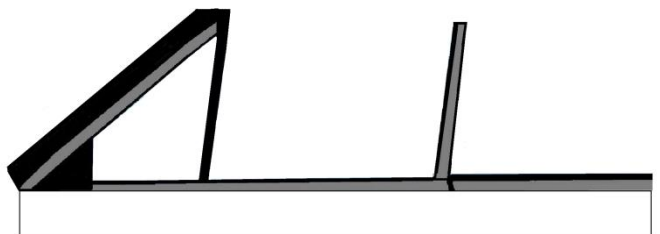
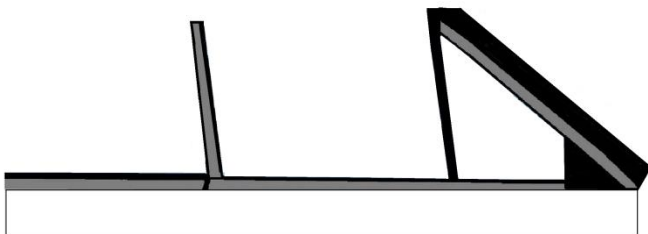

Feste Folie



Feste Folie



Innenseite

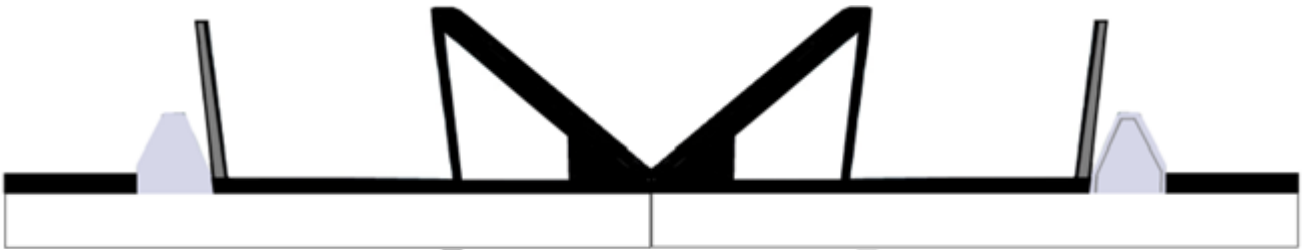

vorne

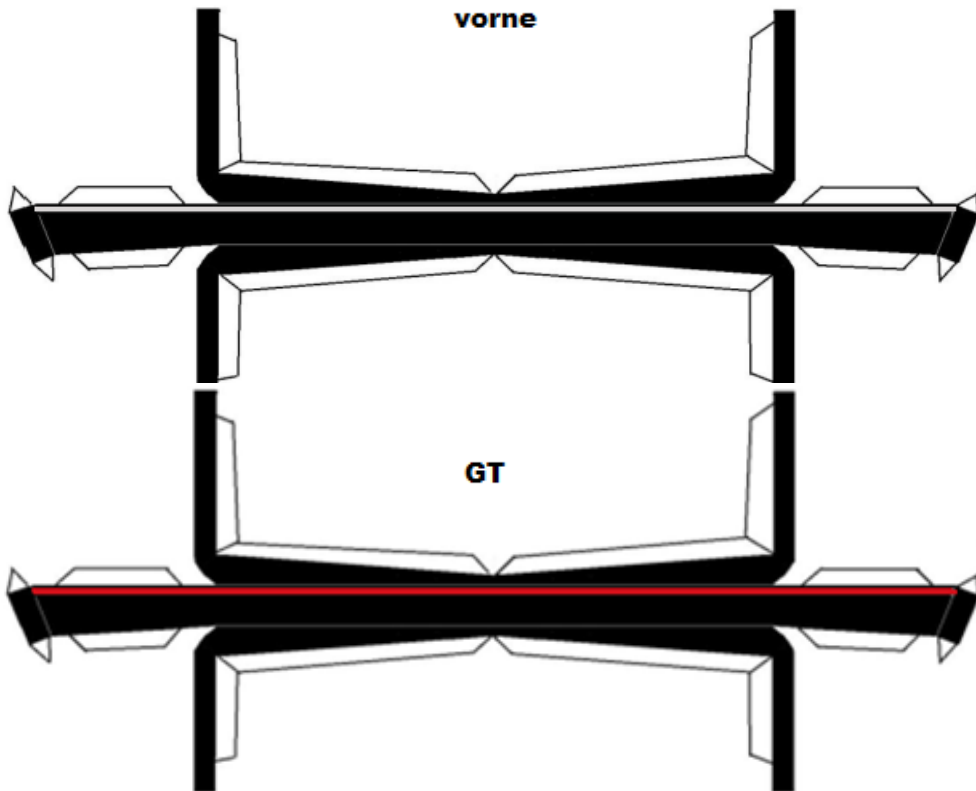

Heckspoiler

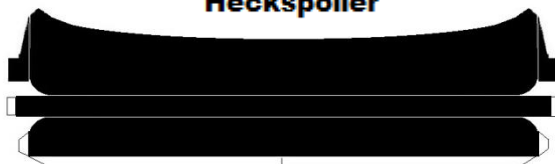

hinten

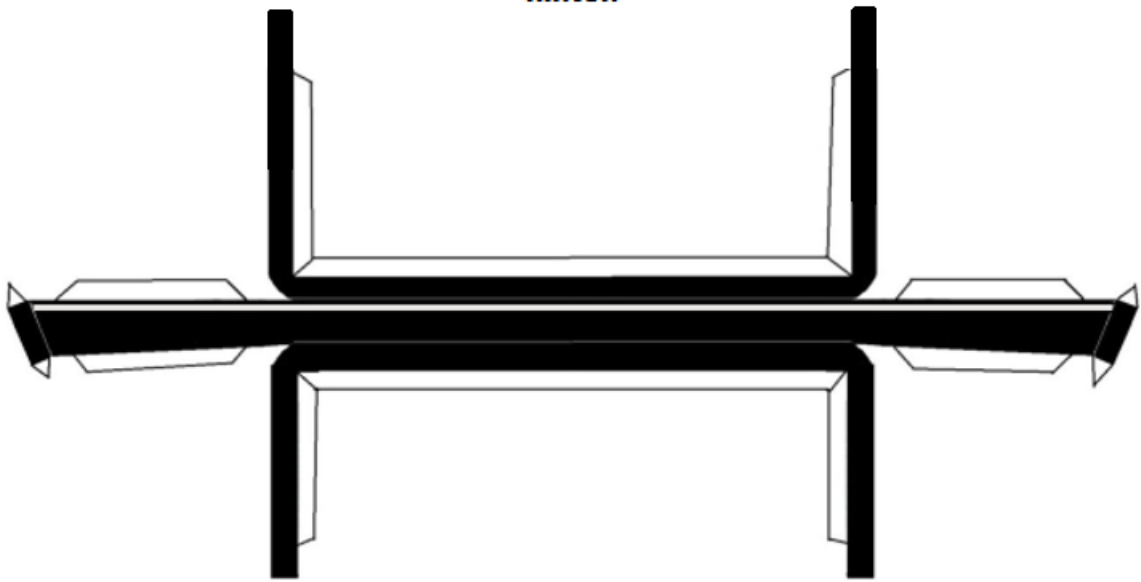

GT

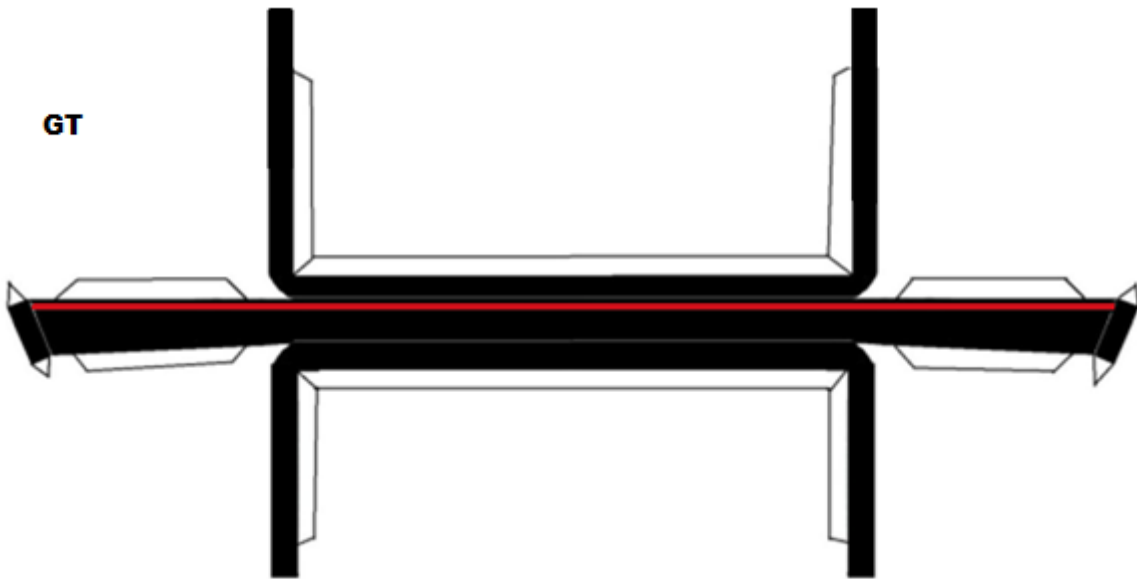

C 3 GT

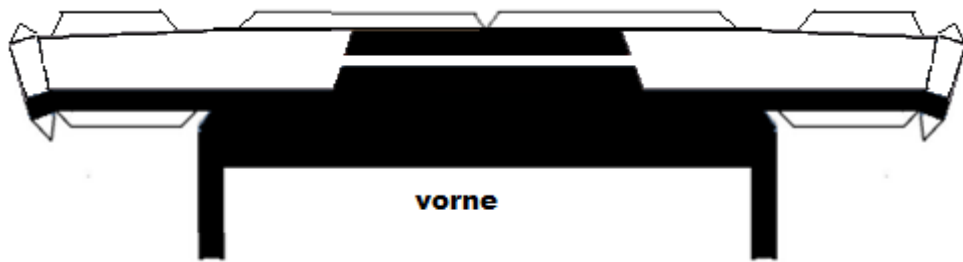

vorne

Seitenschweller



hinten

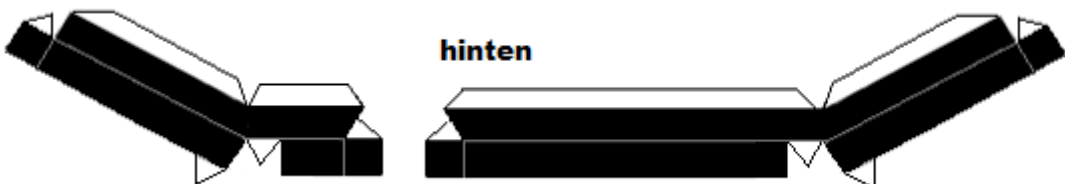

Irscher 1

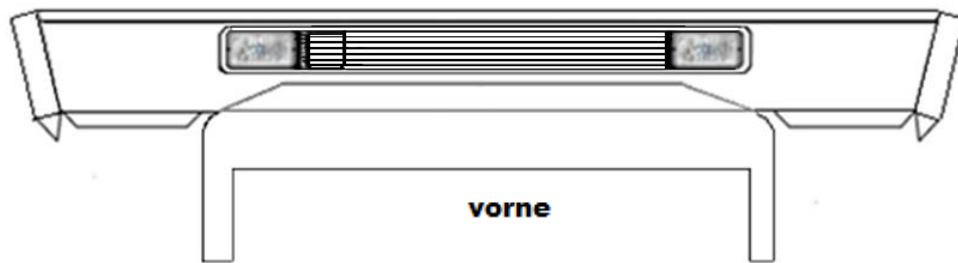

vorne

Seitenschweller

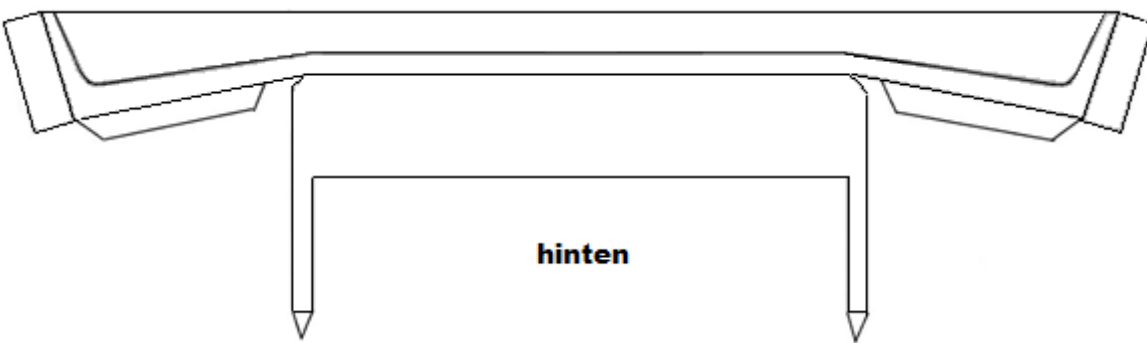
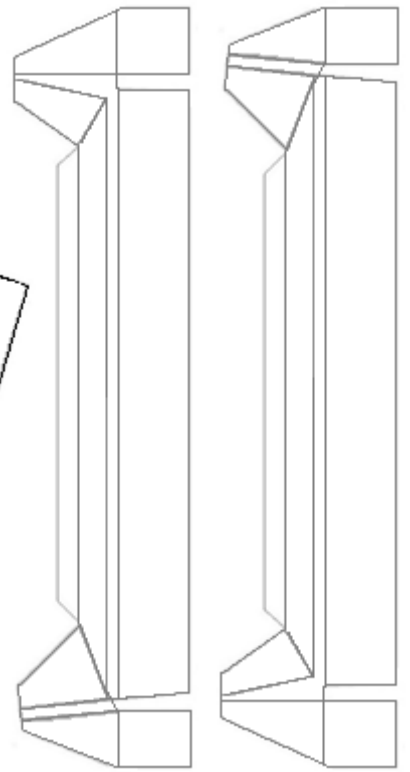

hinten

Mattig

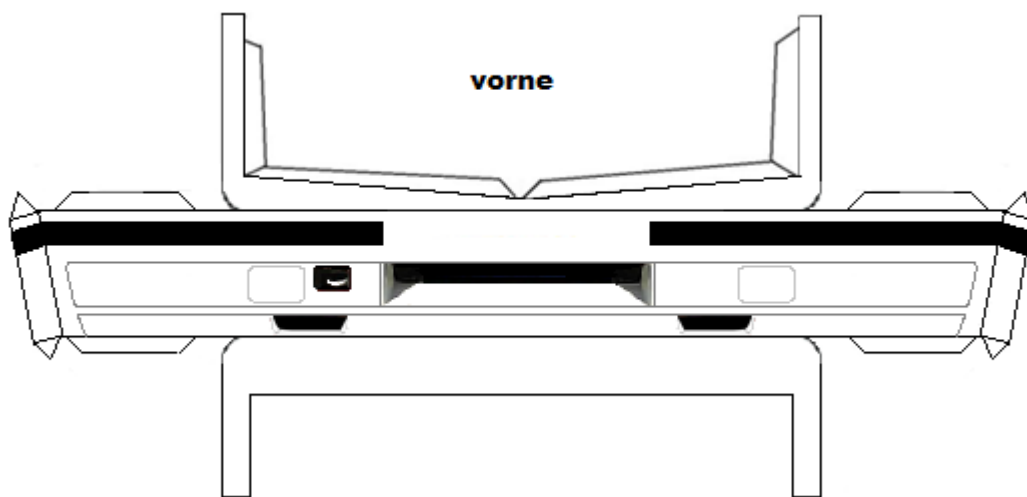

vorne

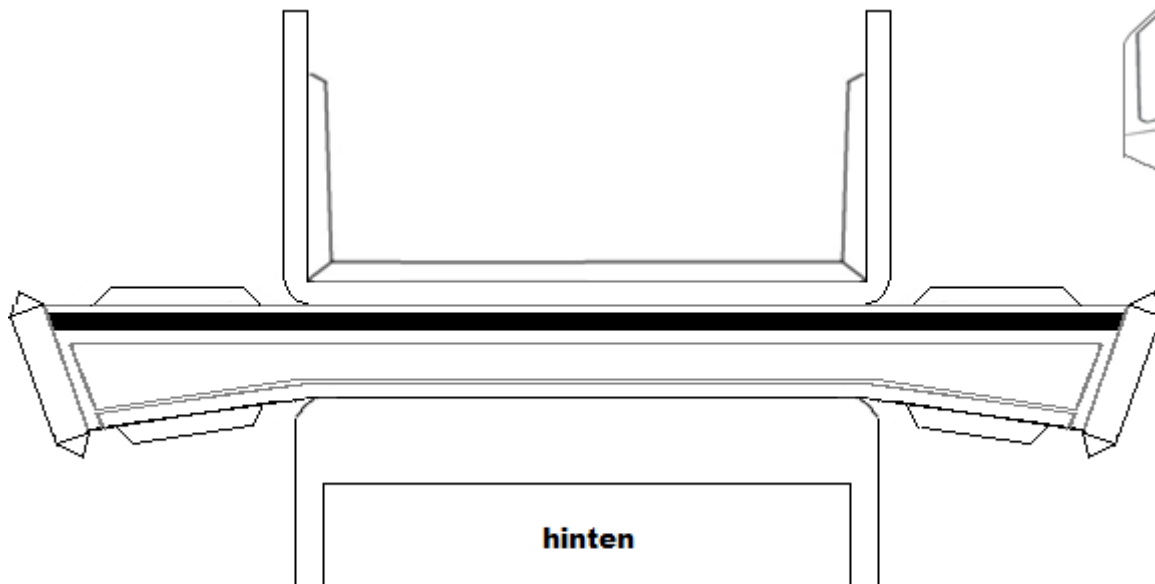
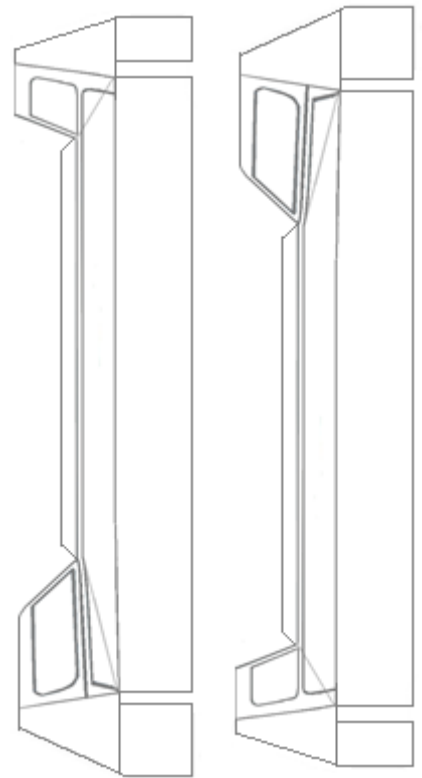

hinten

Räder

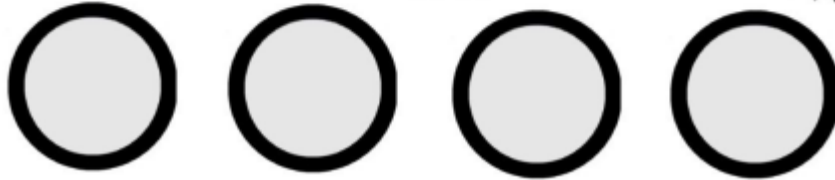
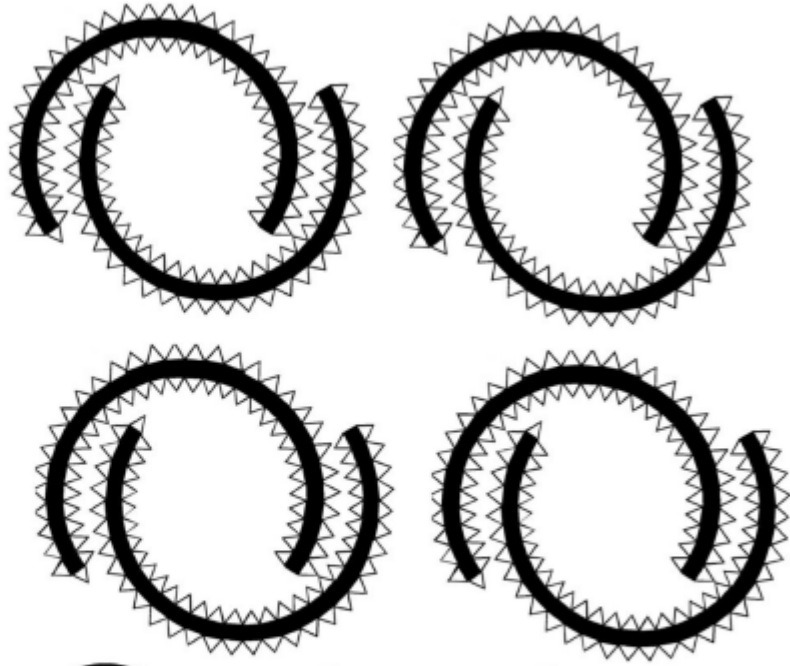
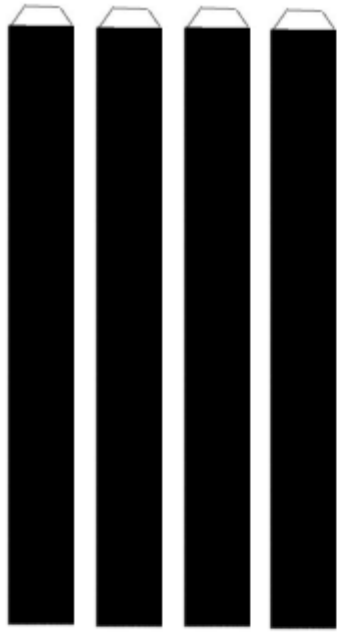

Felgen (Räderfront)

ATS Cup

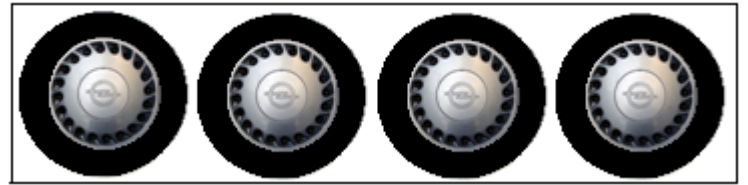
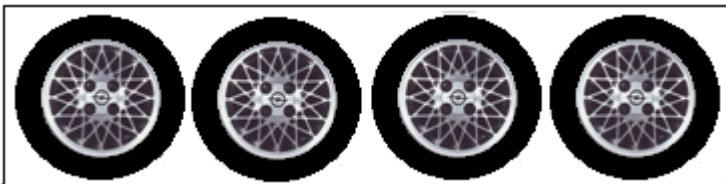
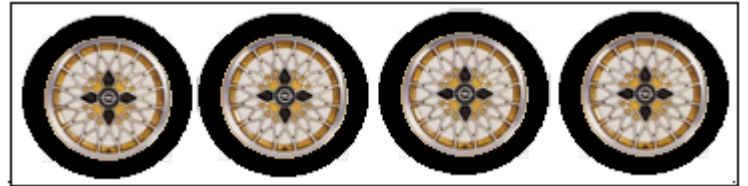
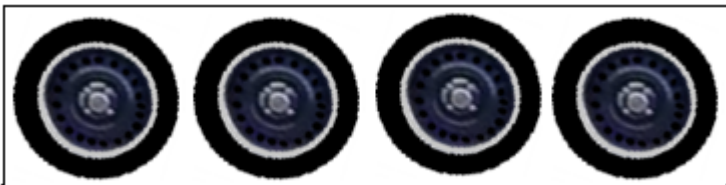
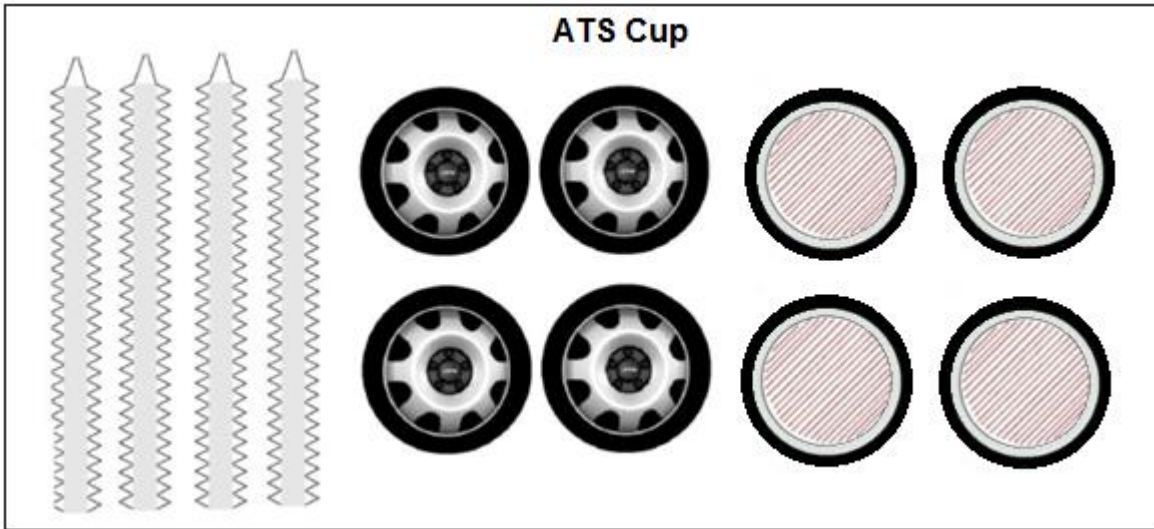

Felgen (Räderfront)

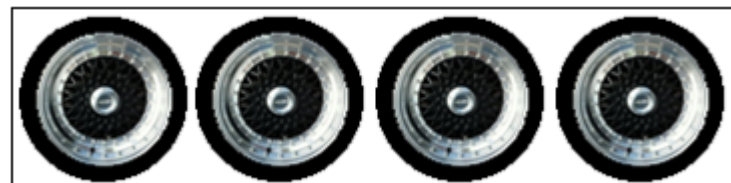

Innenraum

2/4 Türer

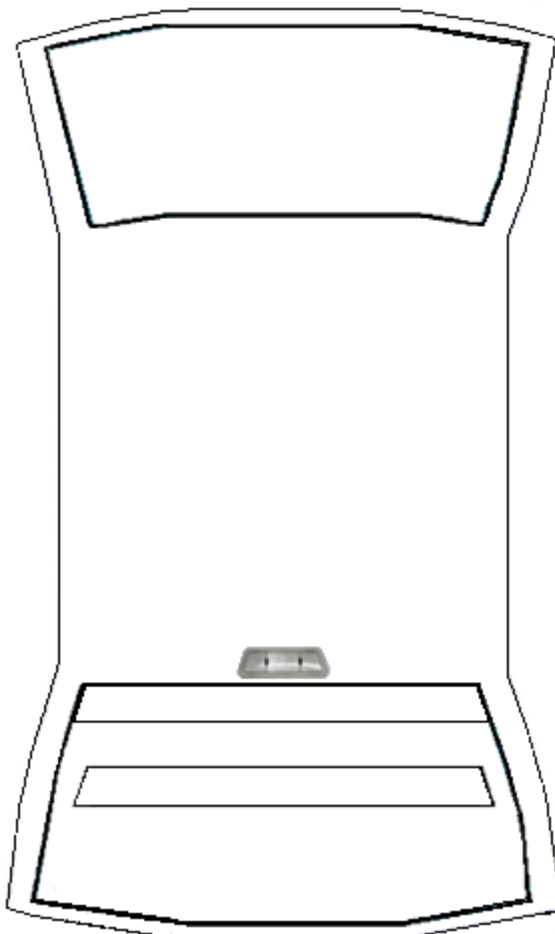

C 1

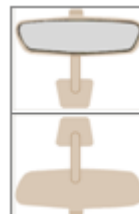
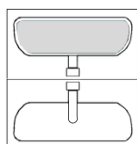
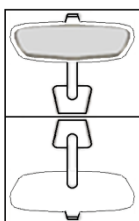

C 1

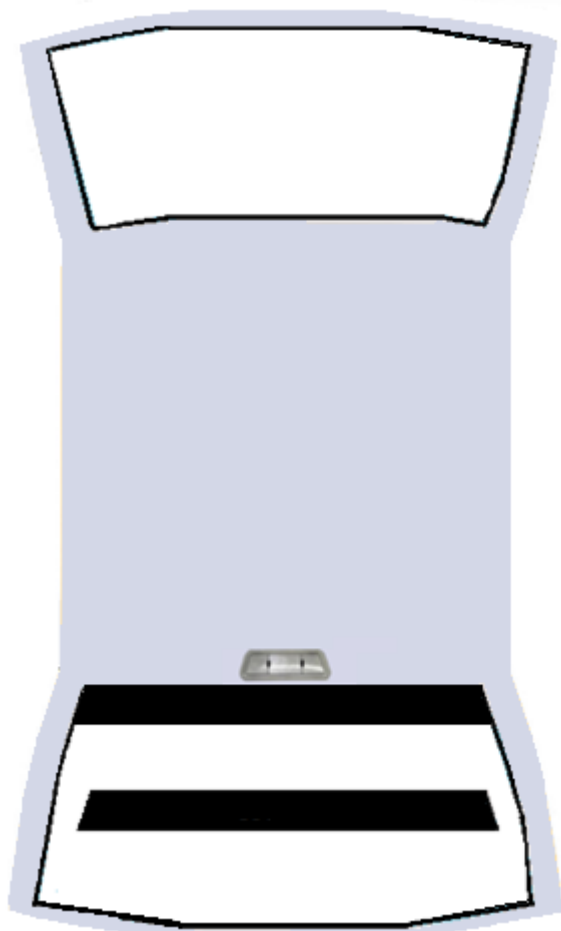
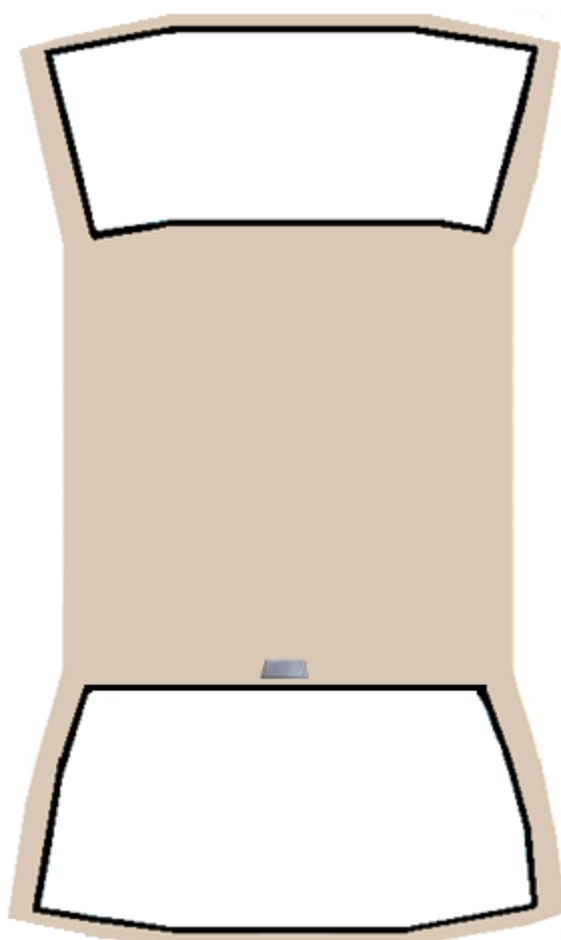
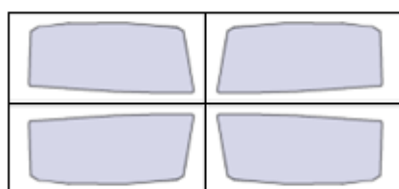
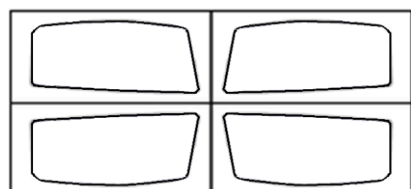

Innenraum 2 Türen

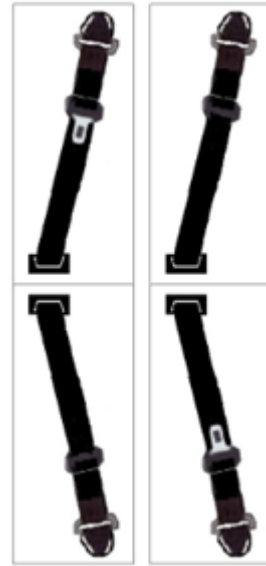
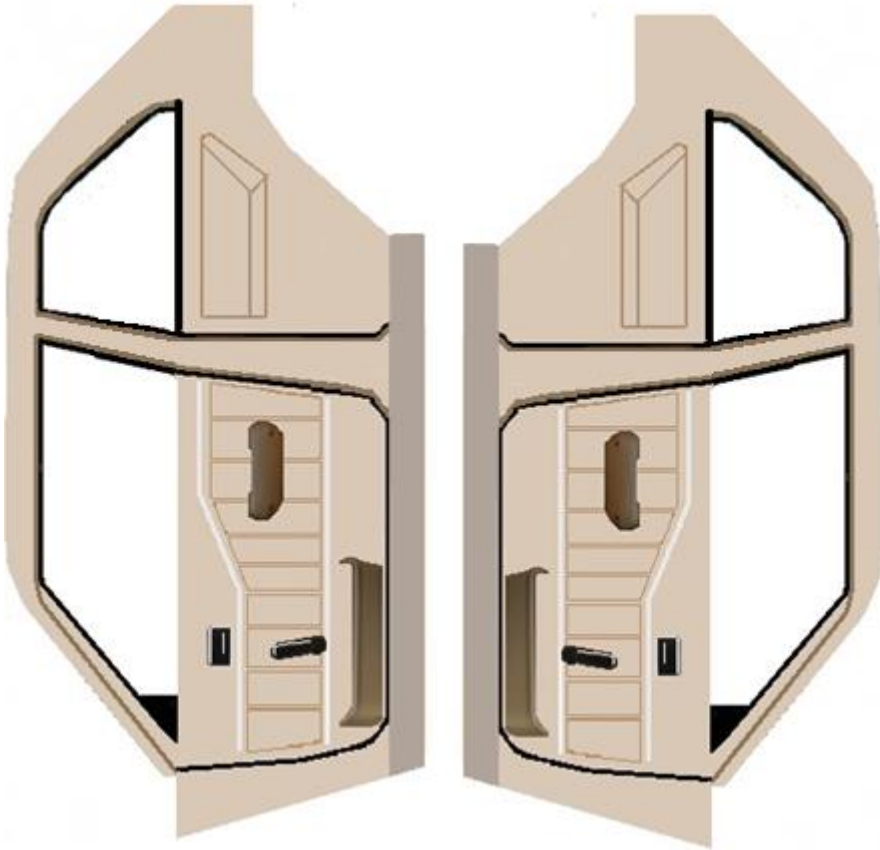
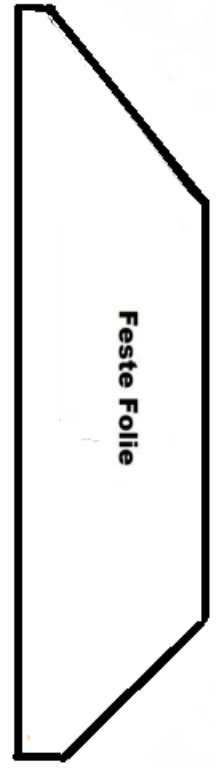
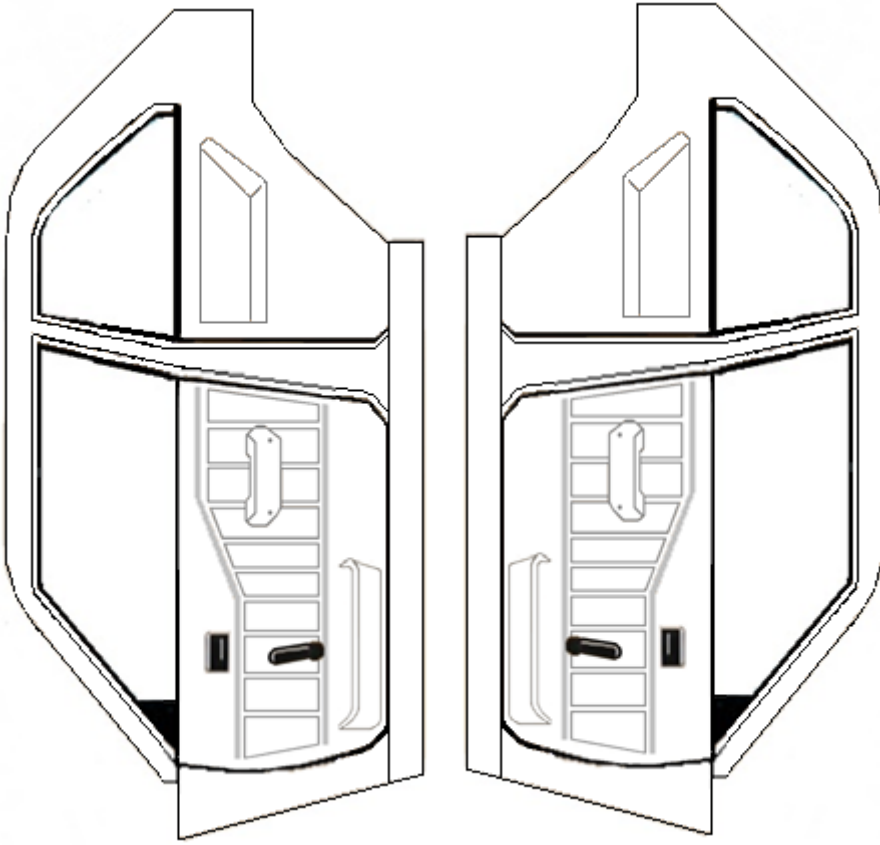

Innenraum 2 Tüer

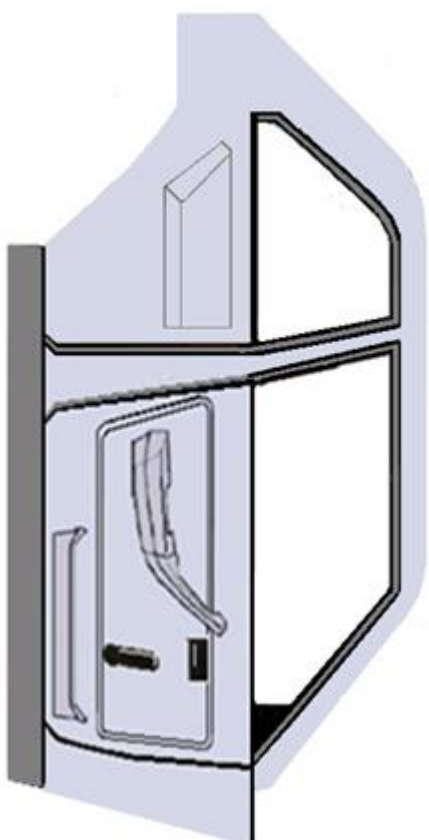
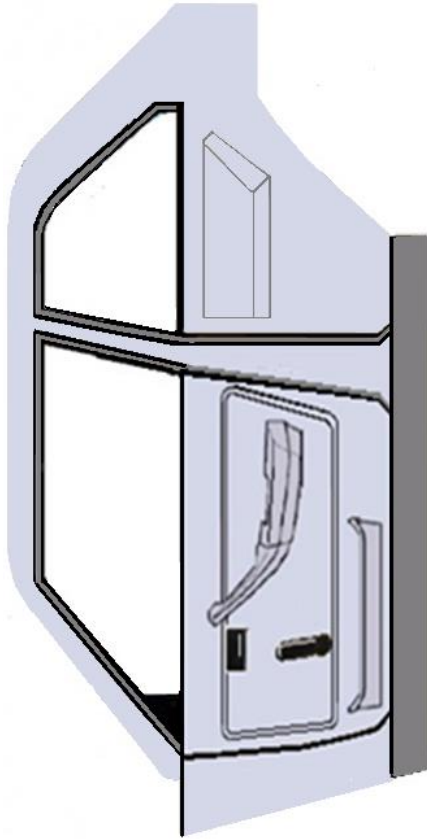
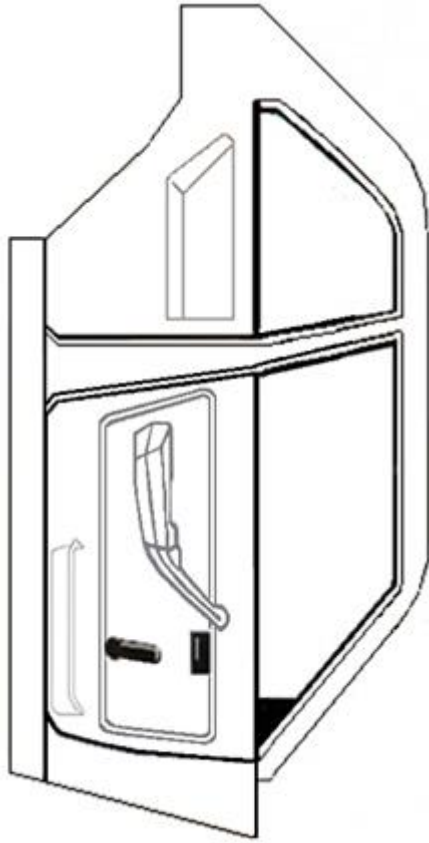
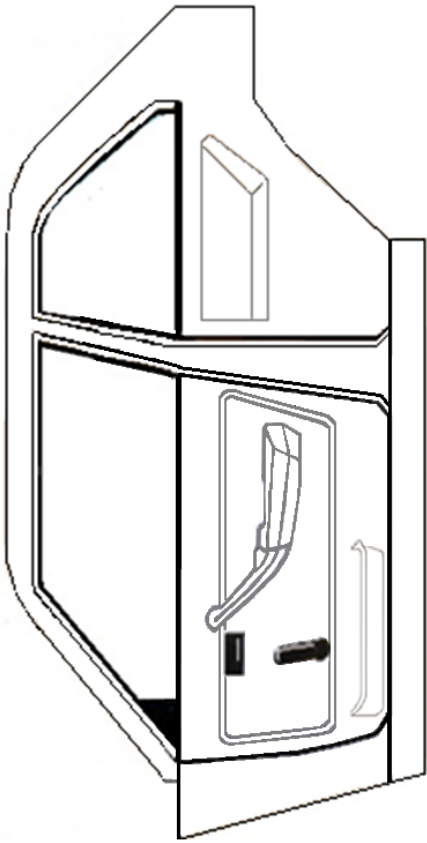

Innenraum 4 Türen

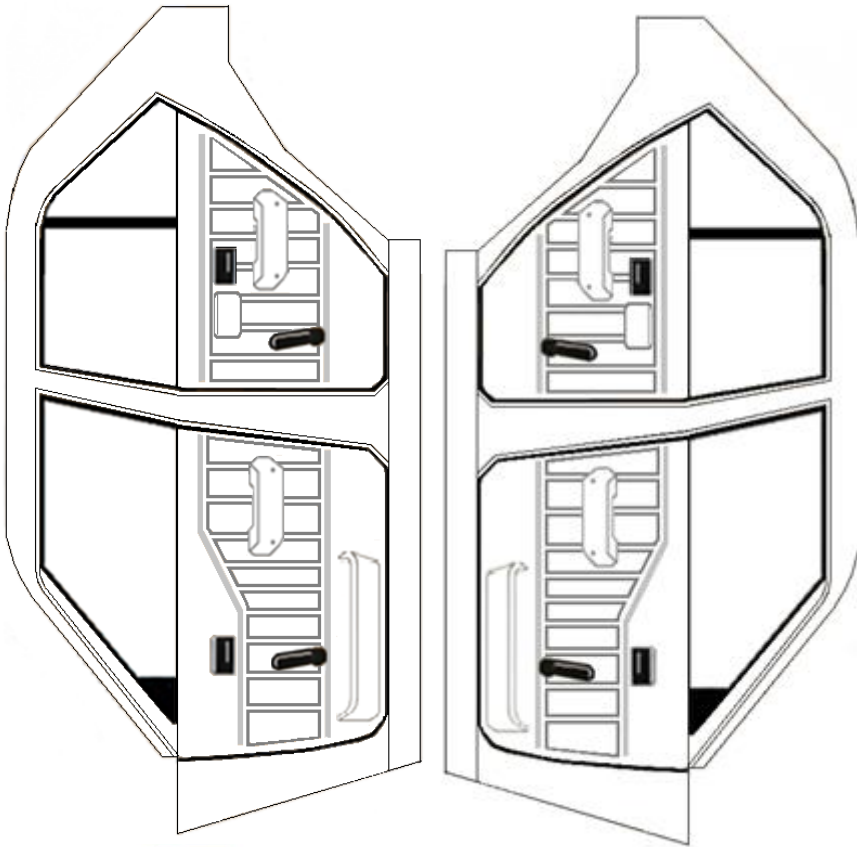

Innenraum 4 Türer

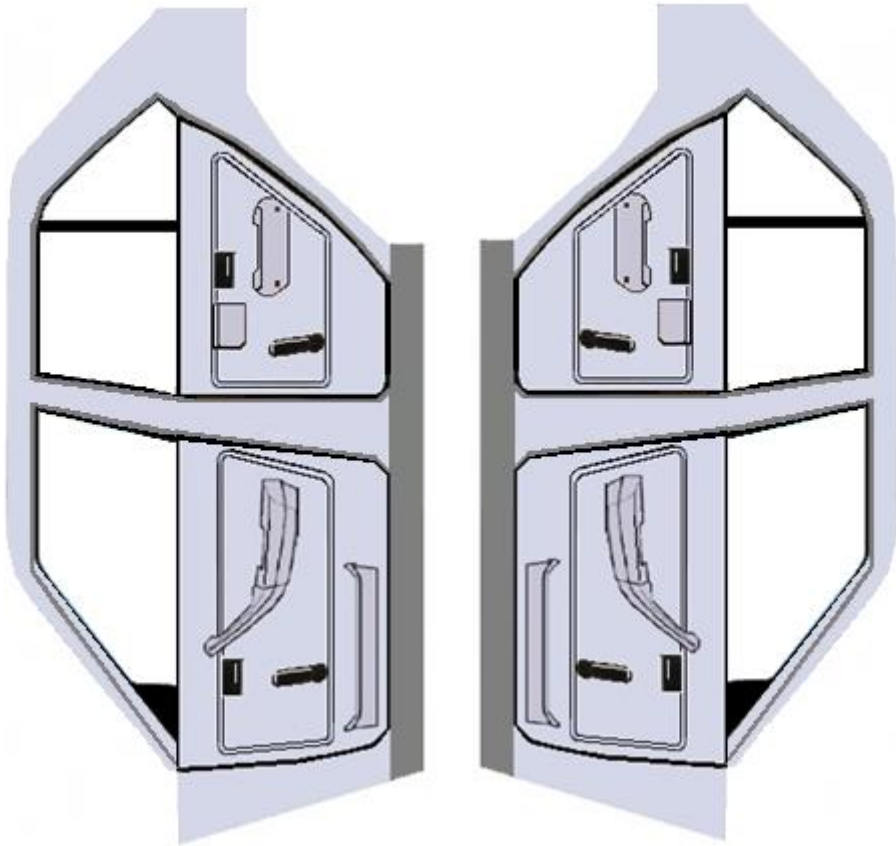
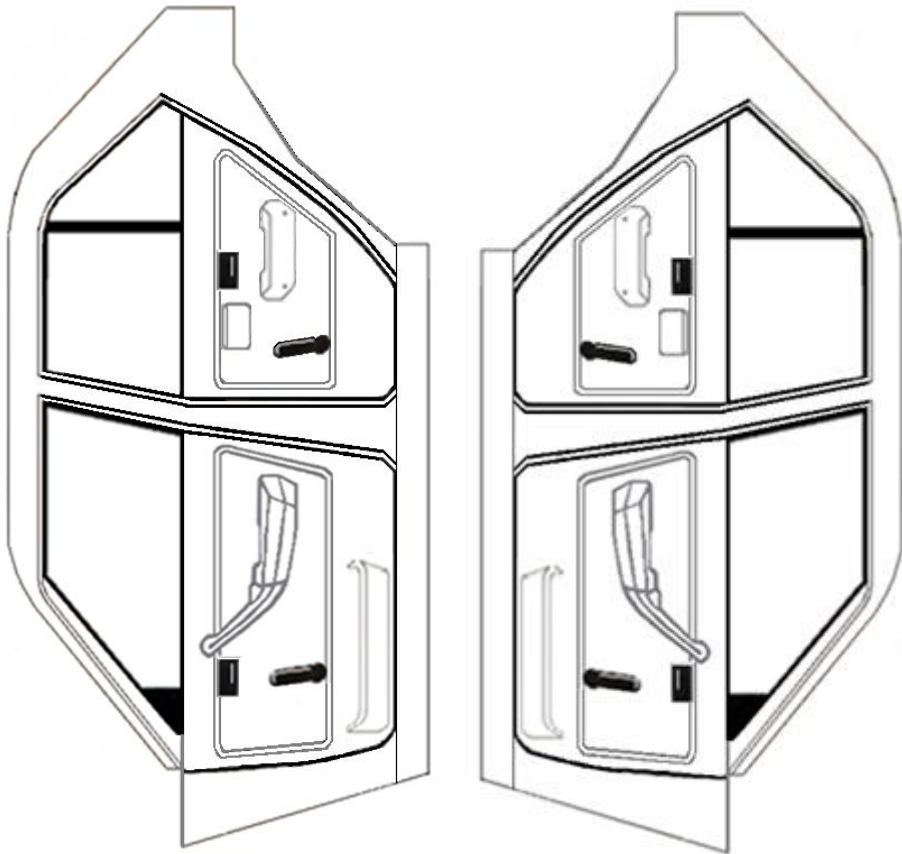

Innenraum CC

C 1

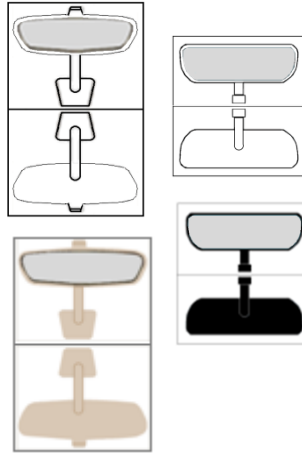

C 1

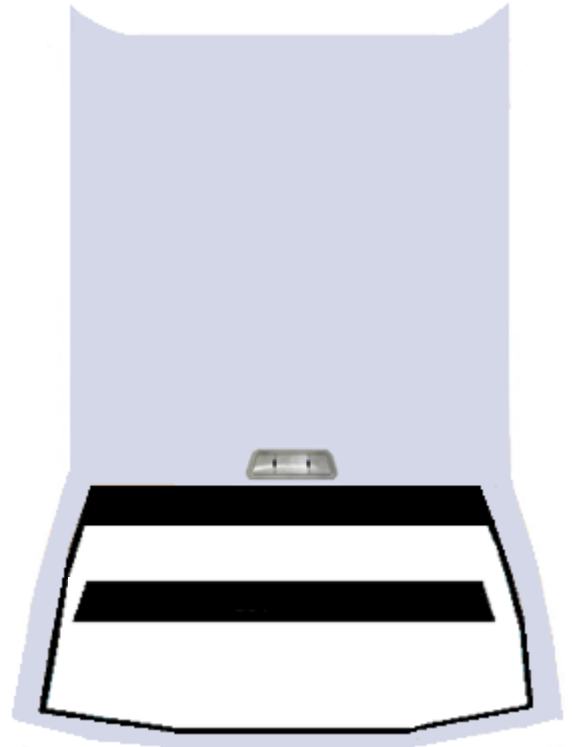
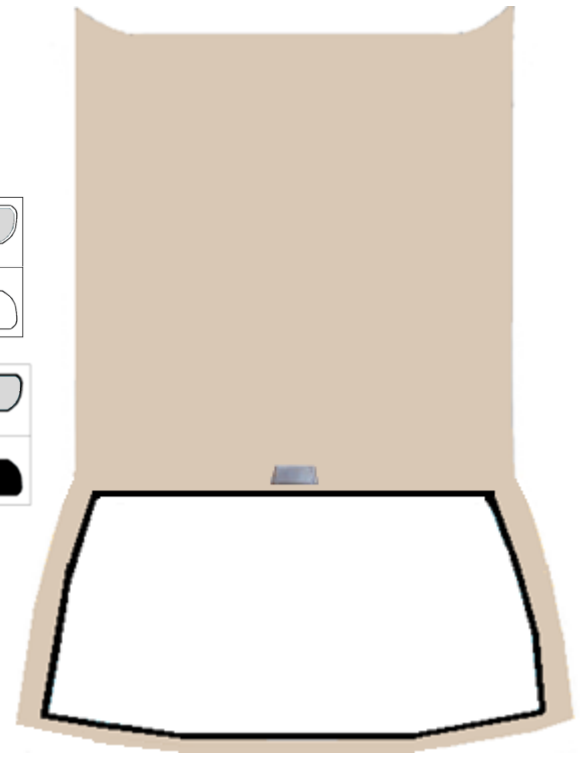
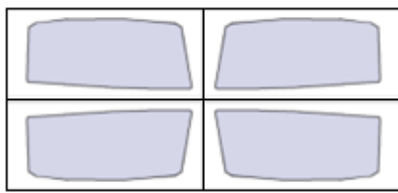
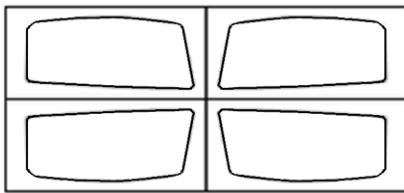
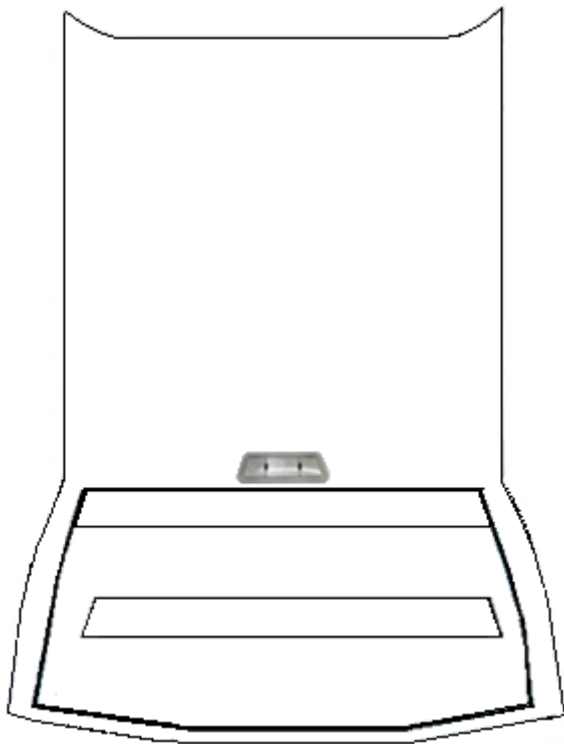

Innenraum CC

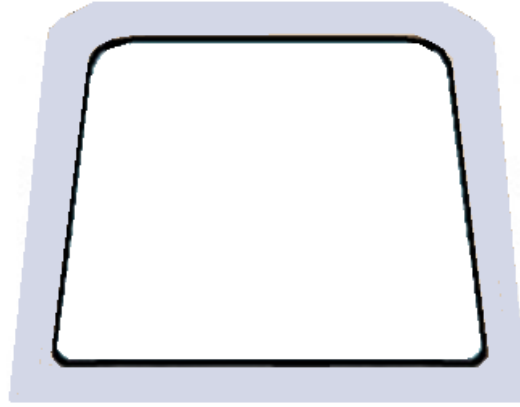
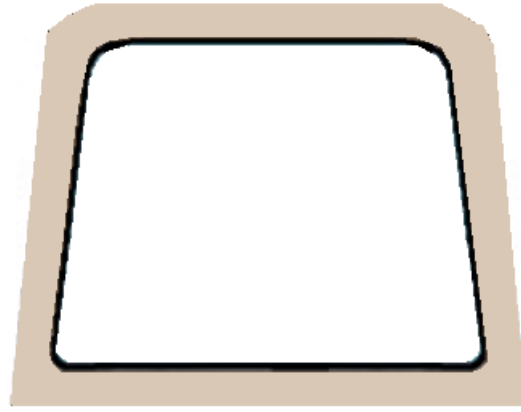
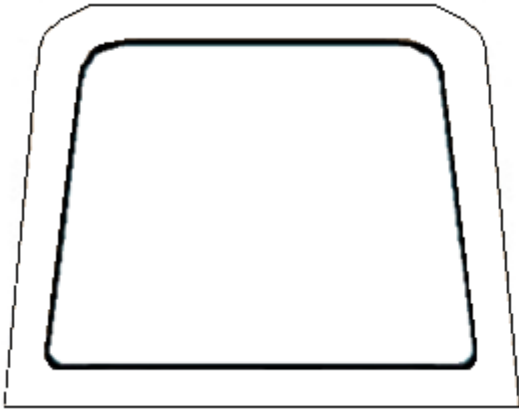

Innenraum CC

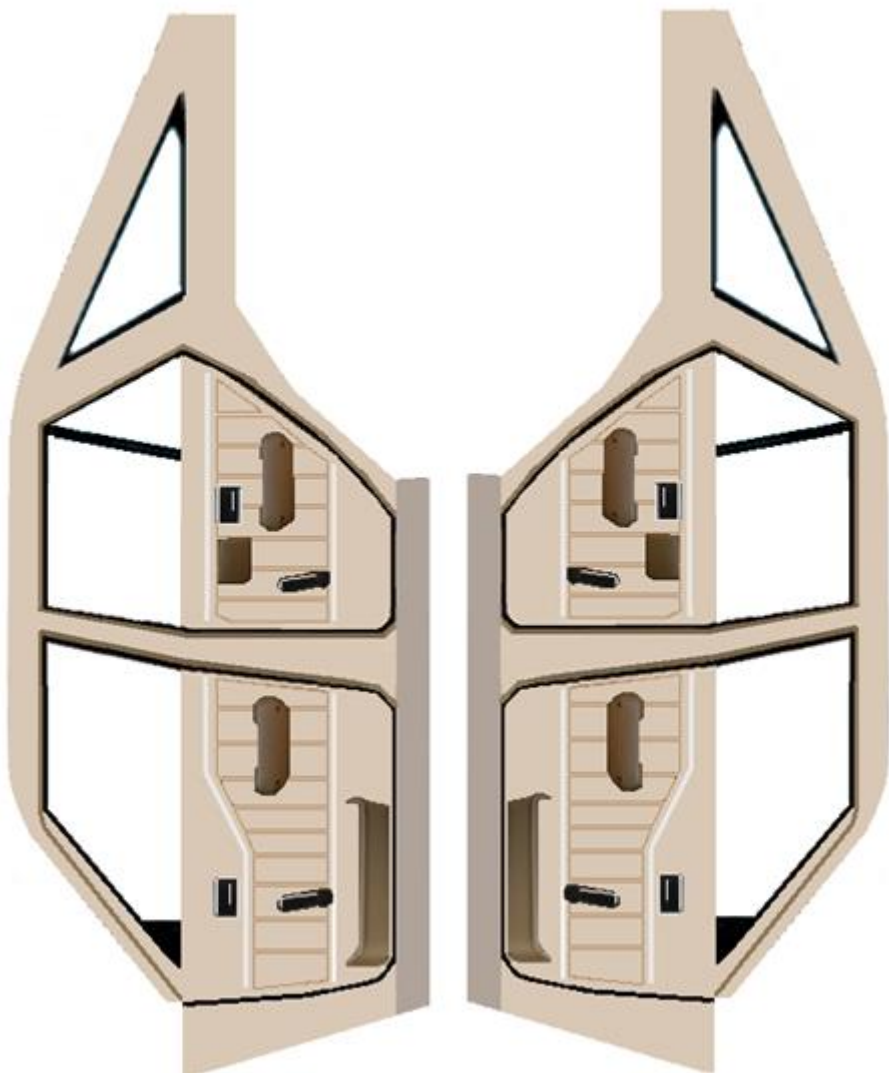
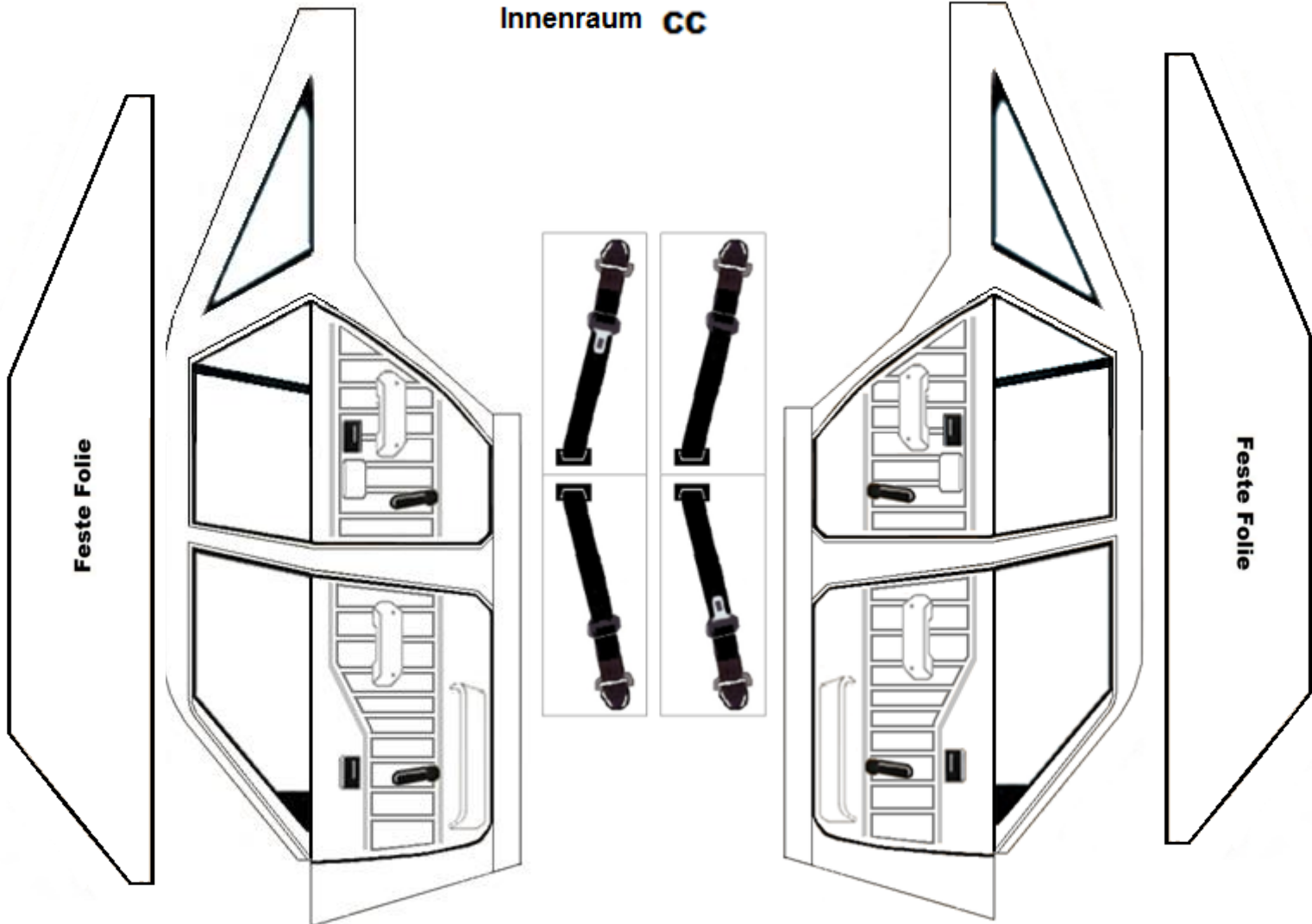

Innenraum CC

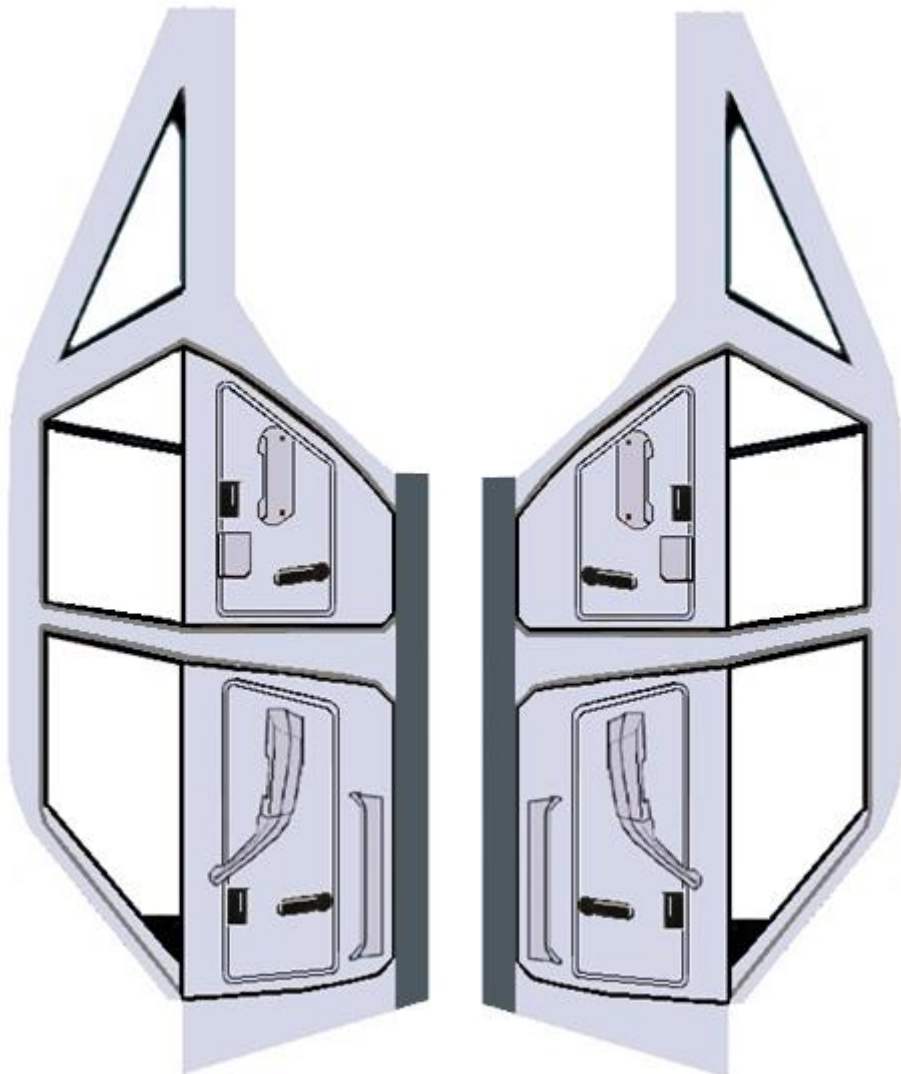
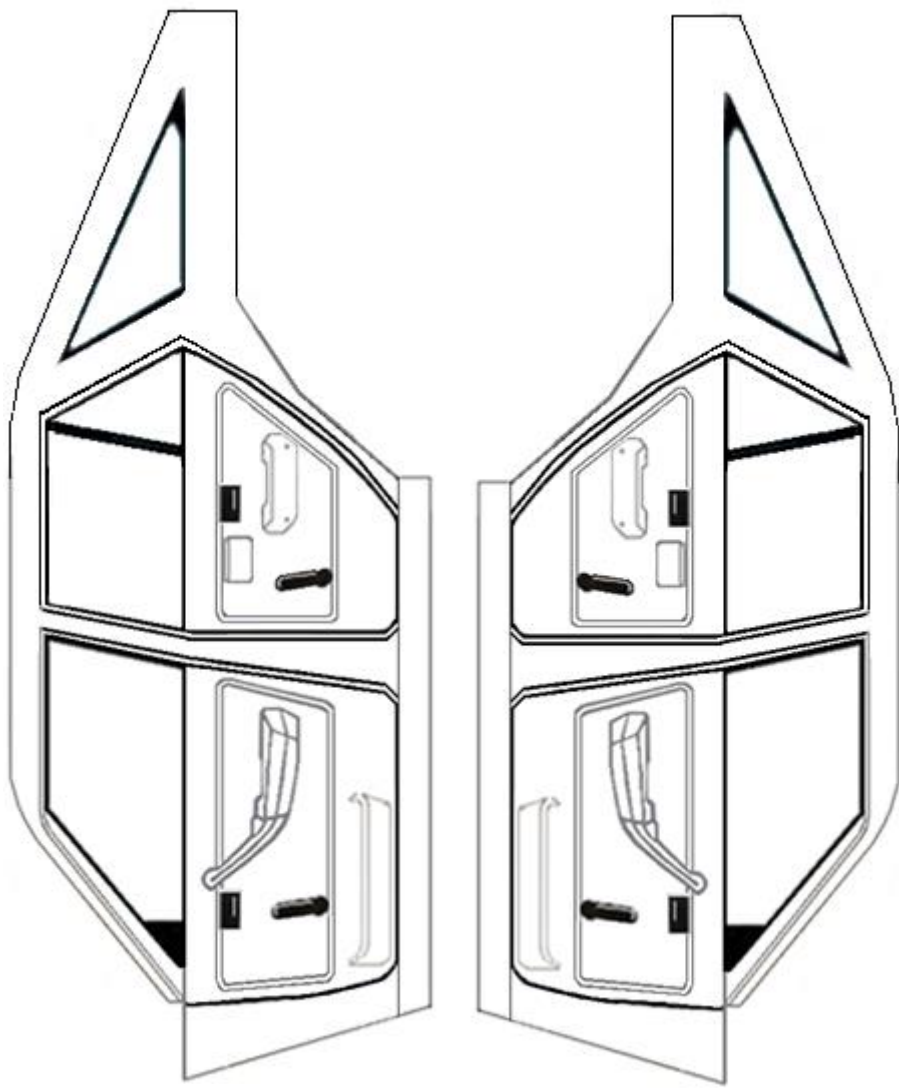

Innenraum

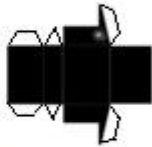
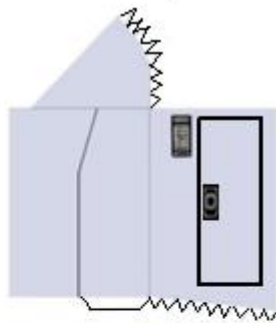
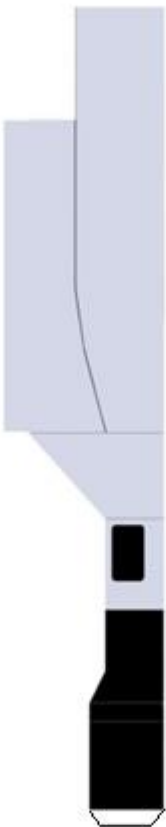
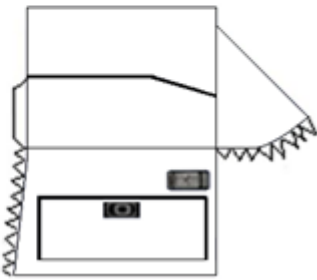
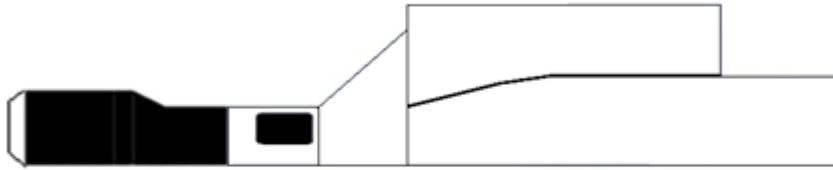
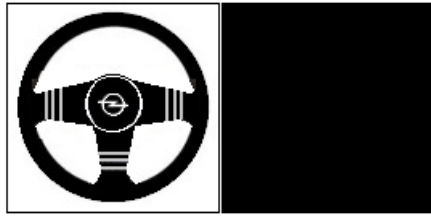

Innenraum

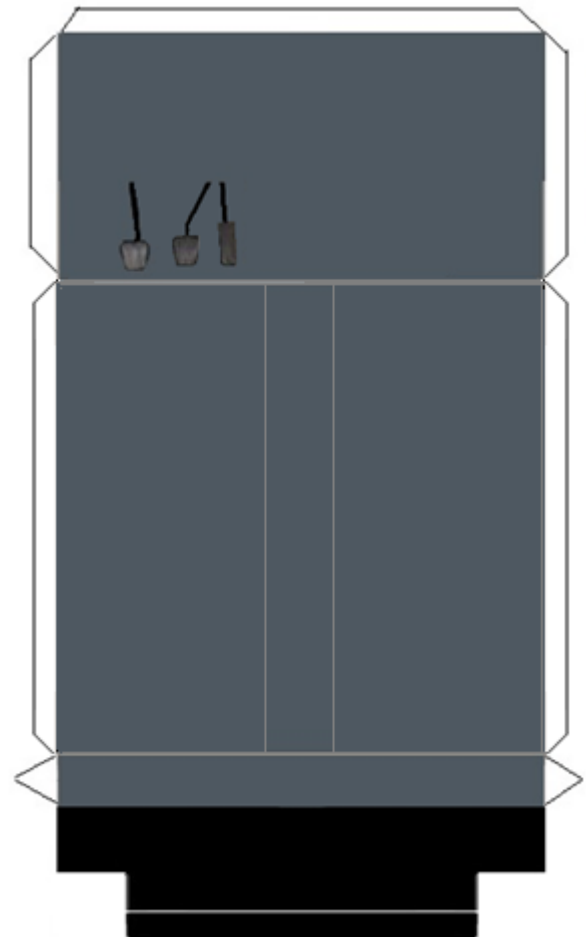
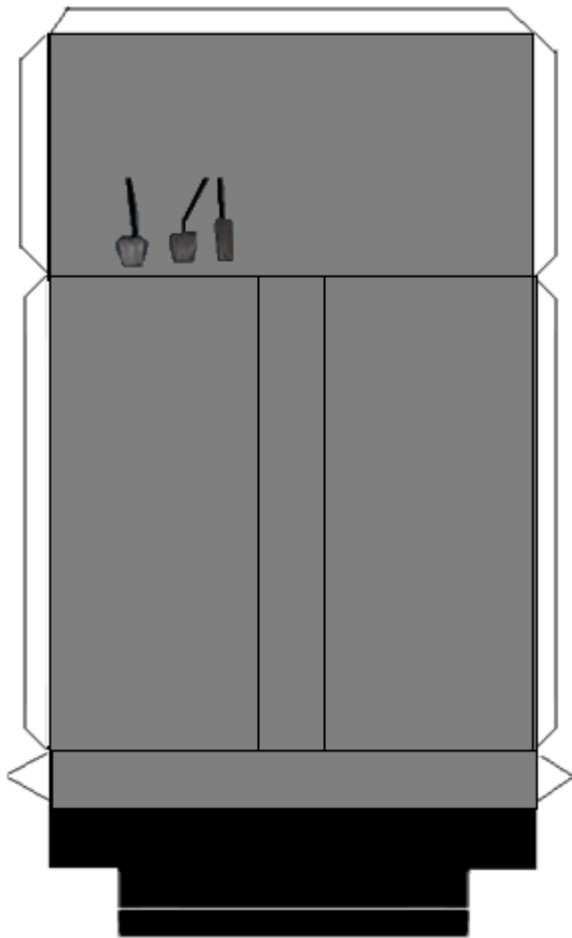
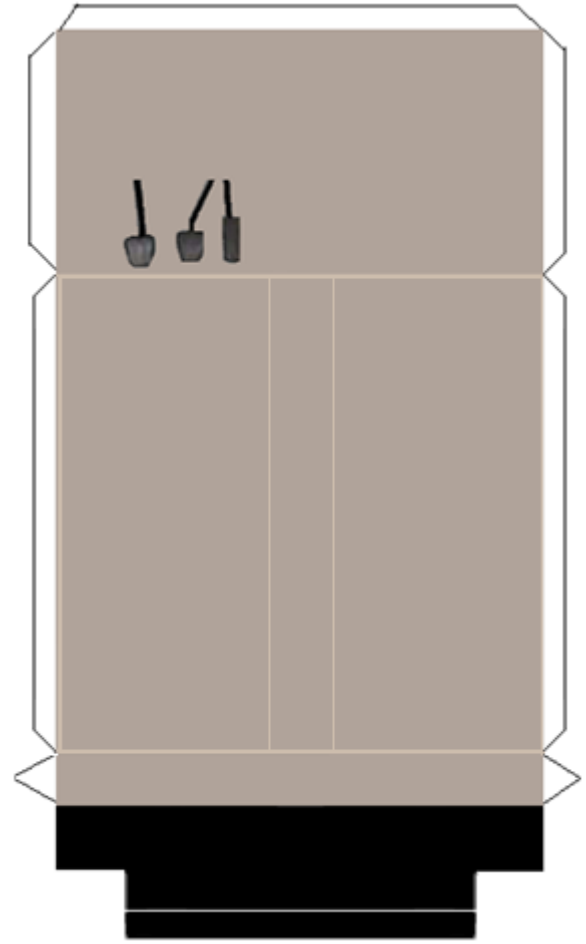
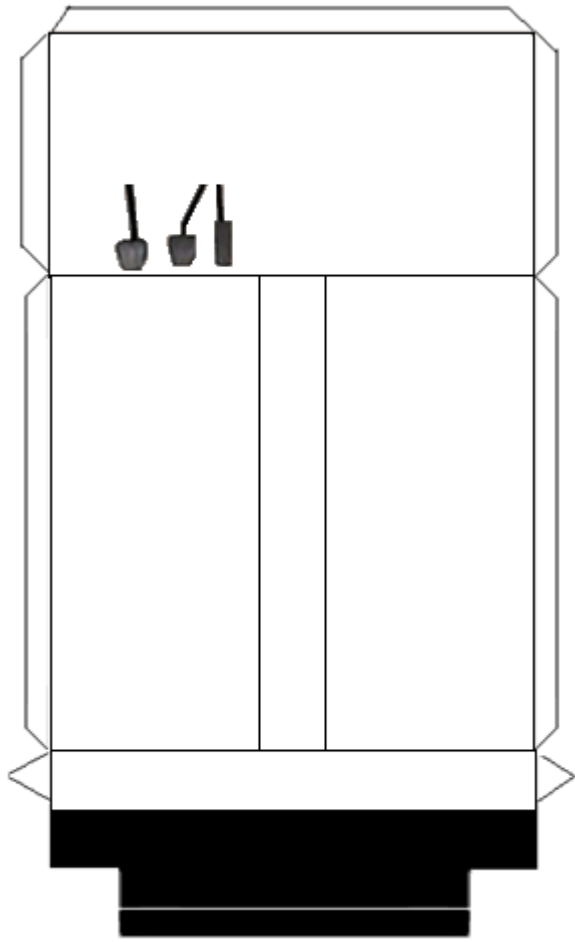

Innenraum Cabrio offen

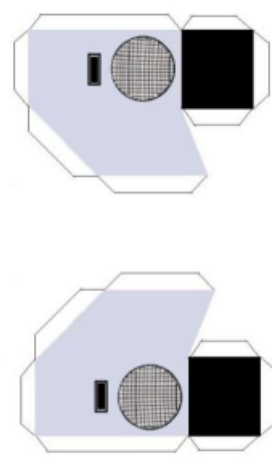
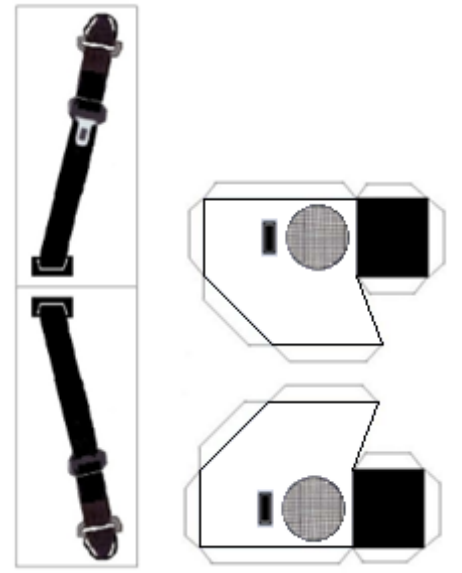
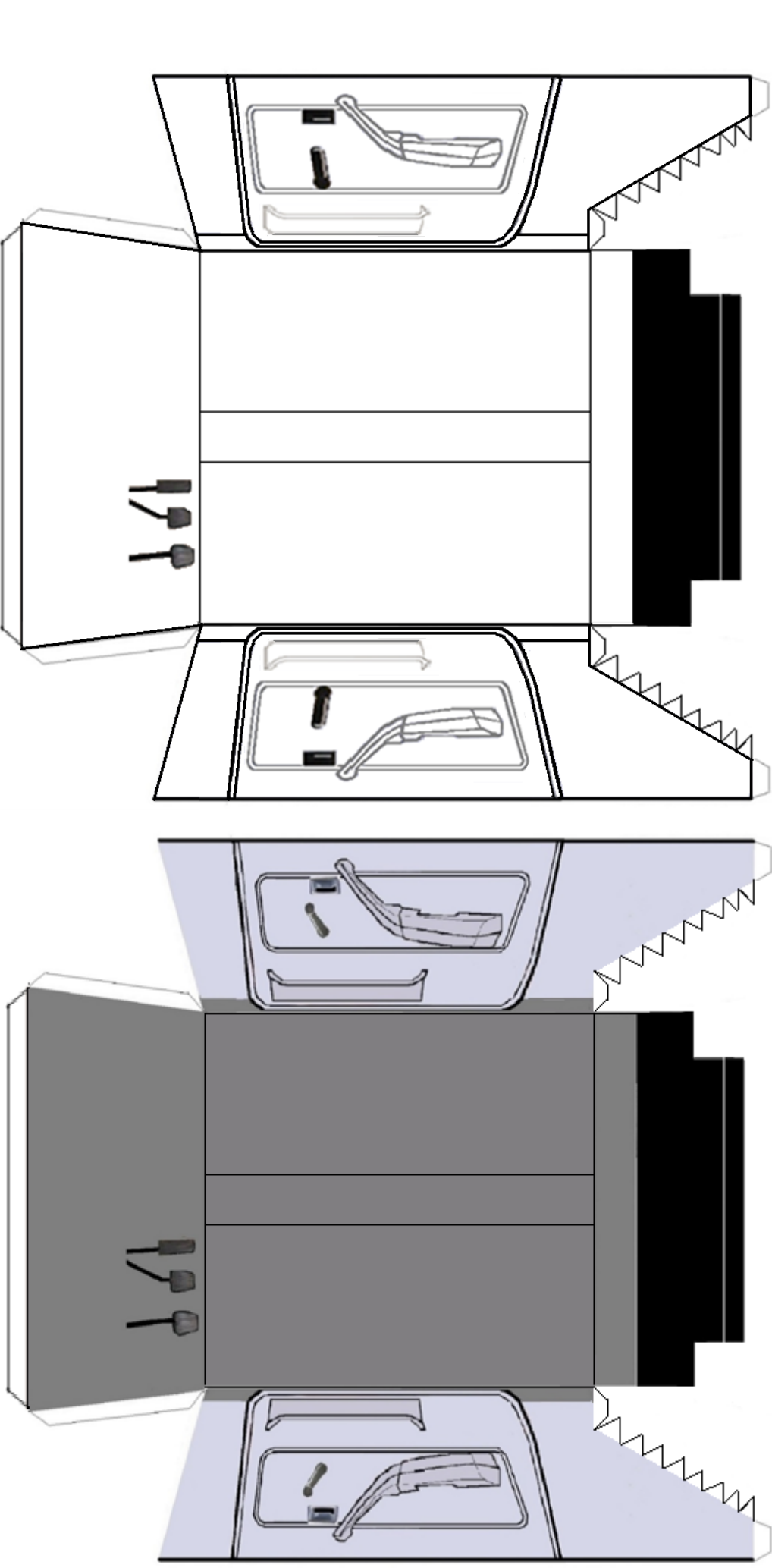

Innenraum

C 1

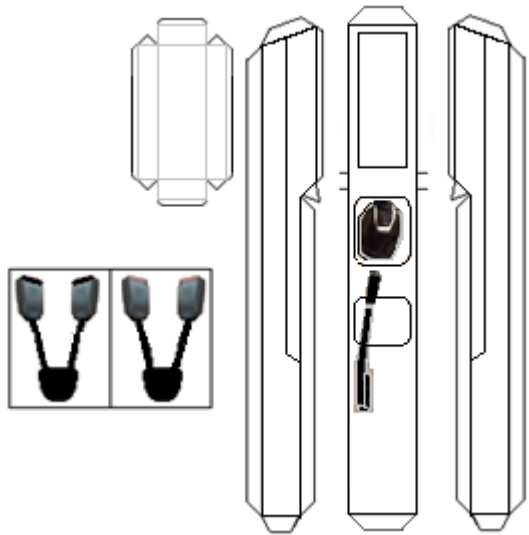

C 2/3

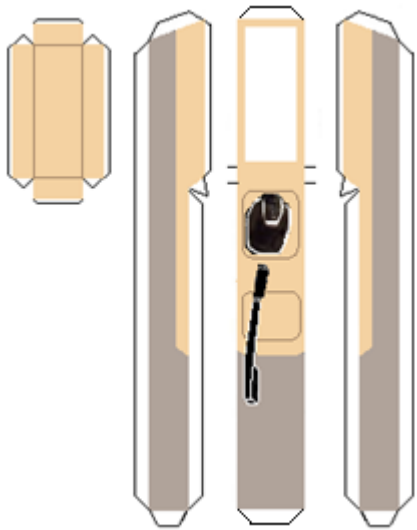
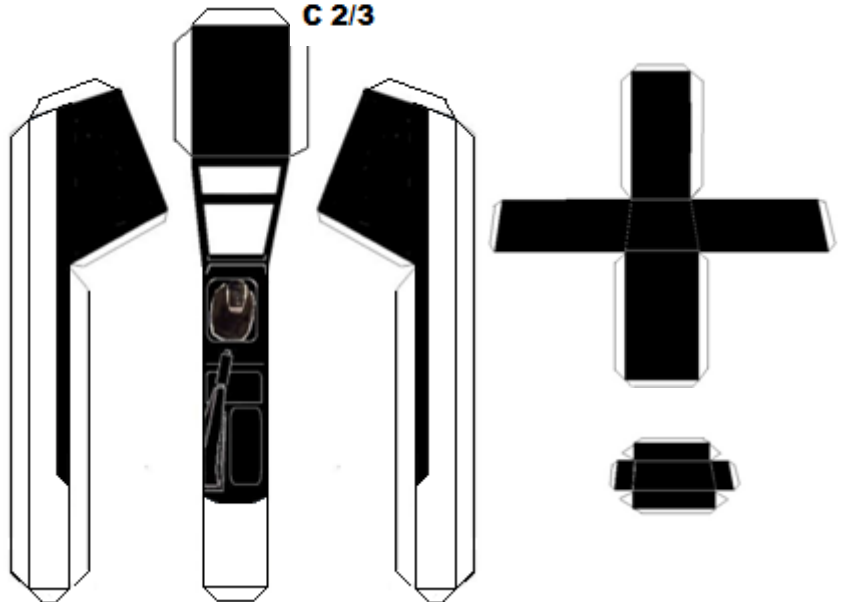

2/4 Türer

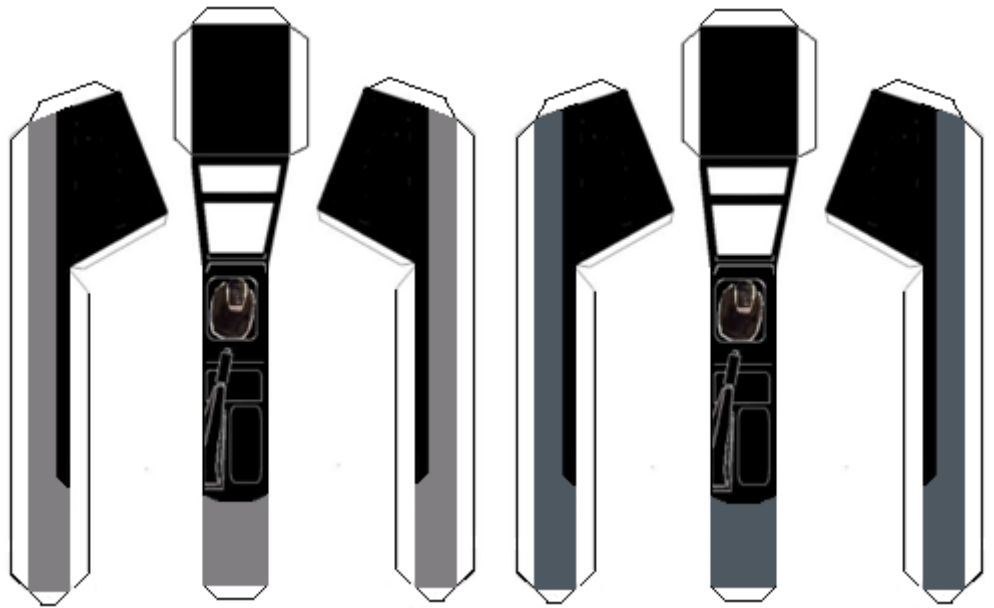

CC

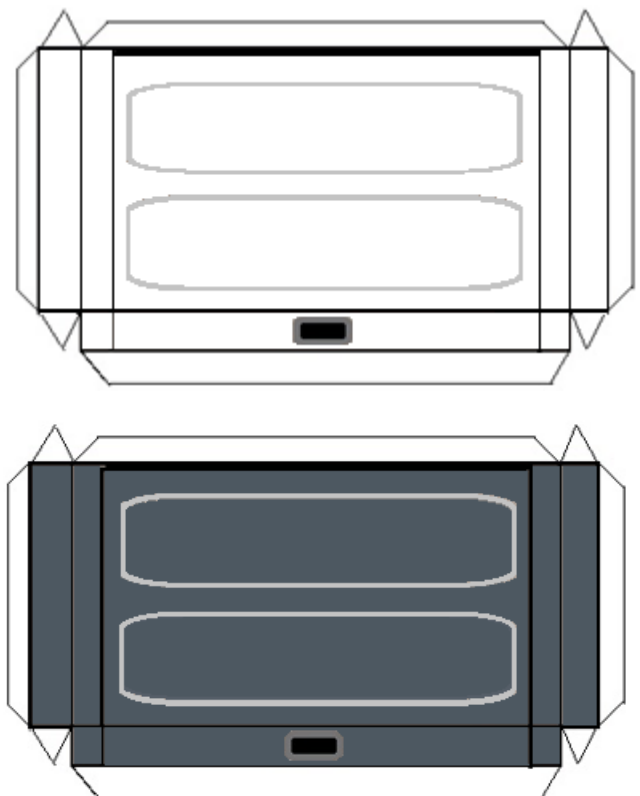
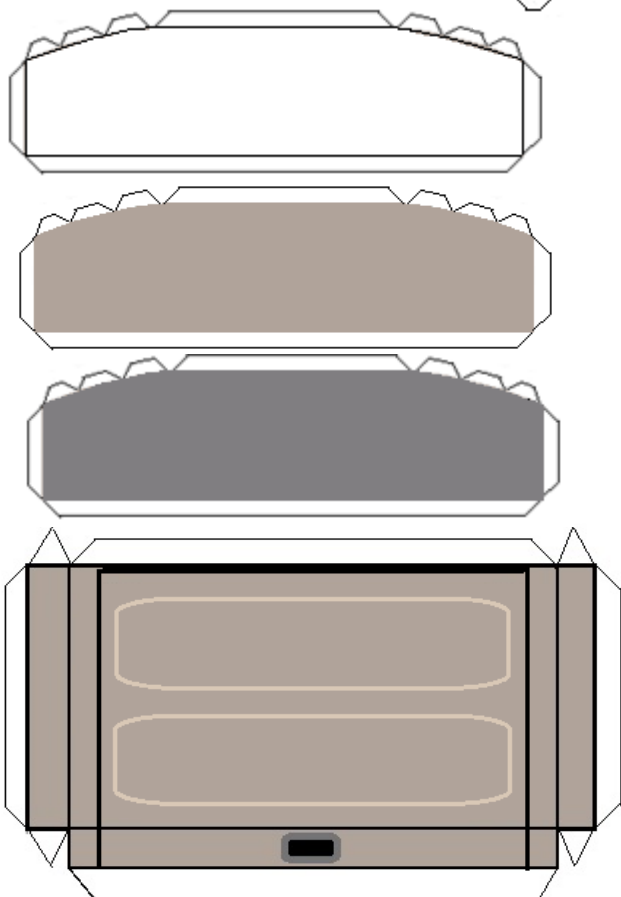

Innenraum

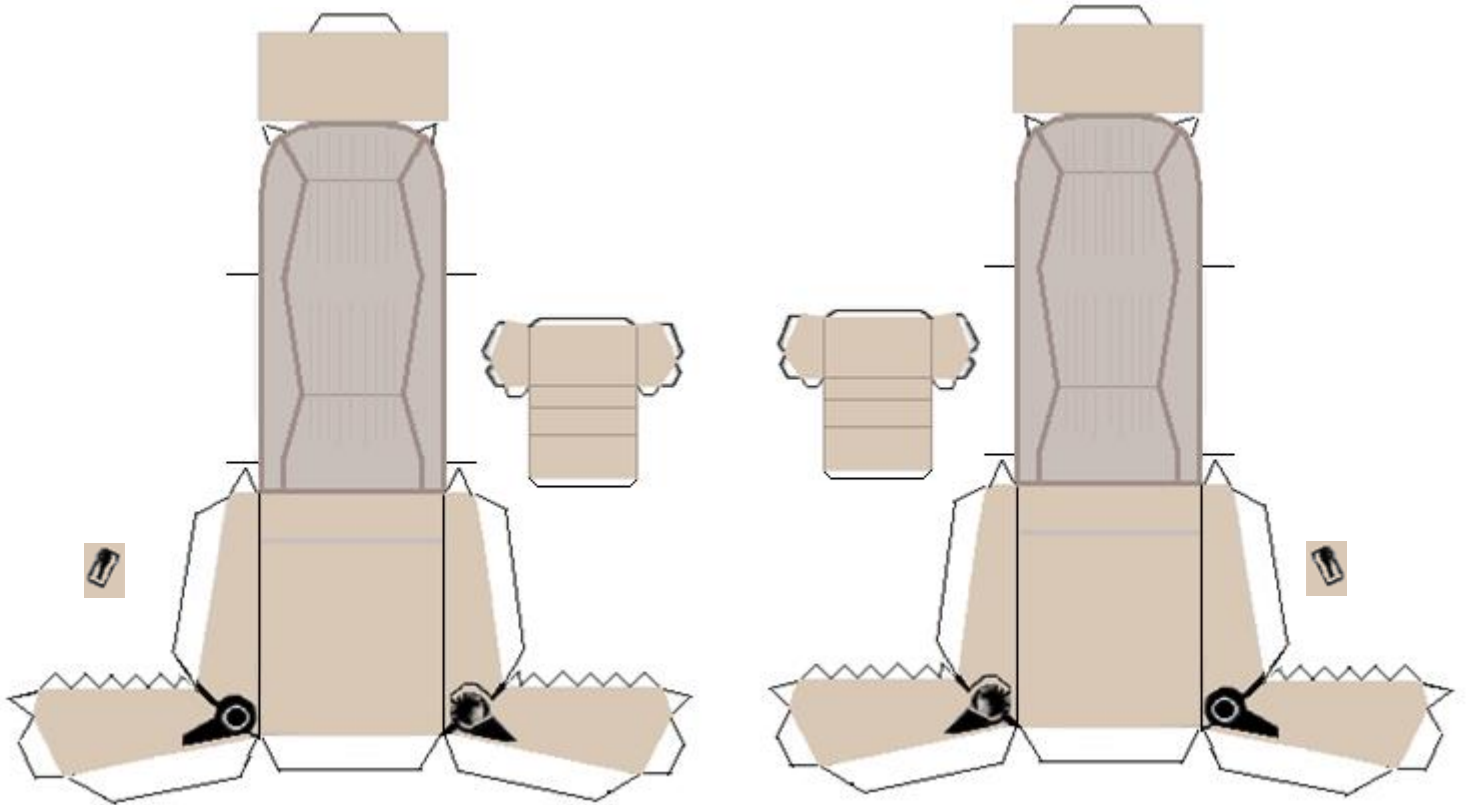
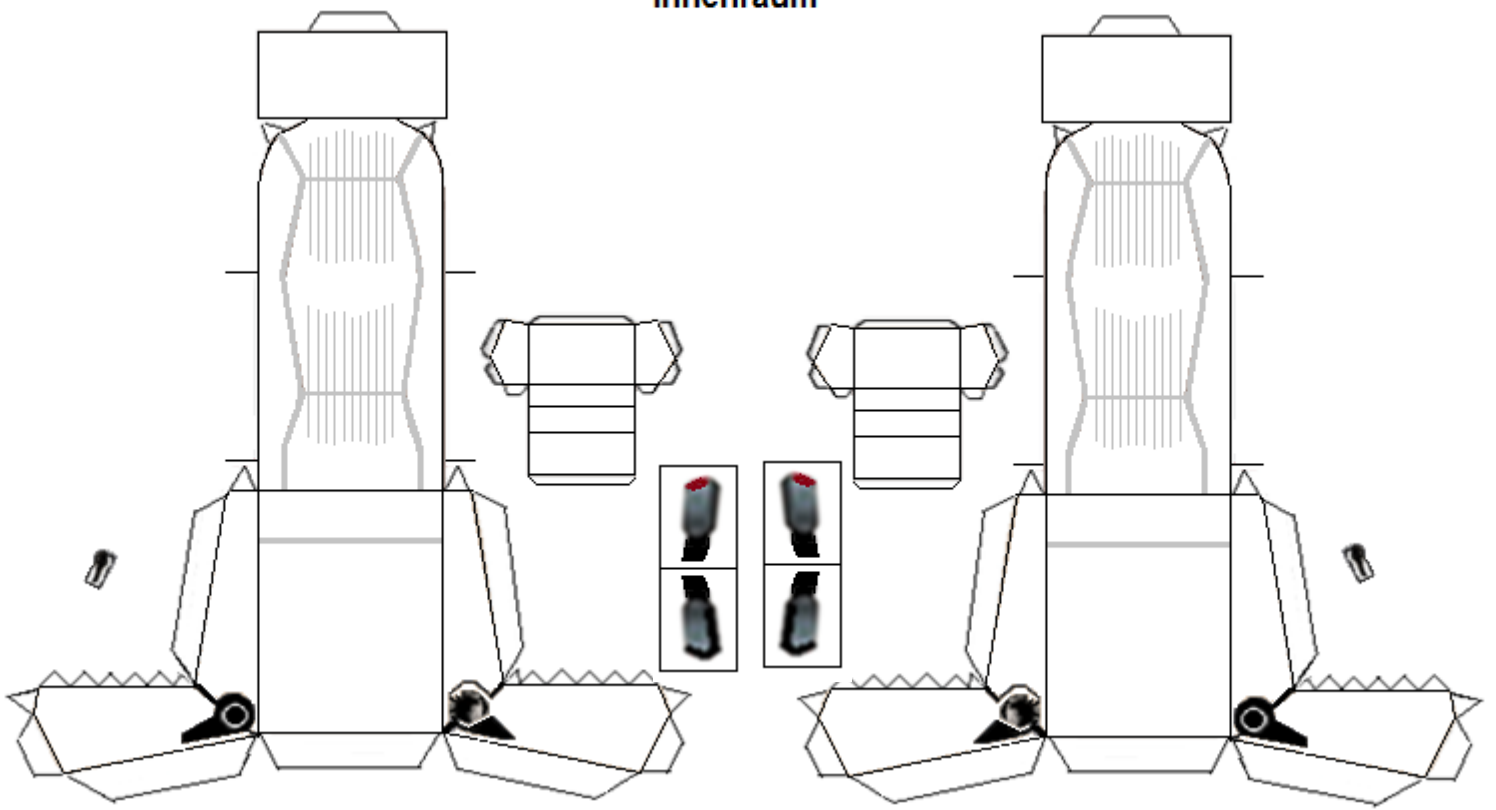

Innenraum

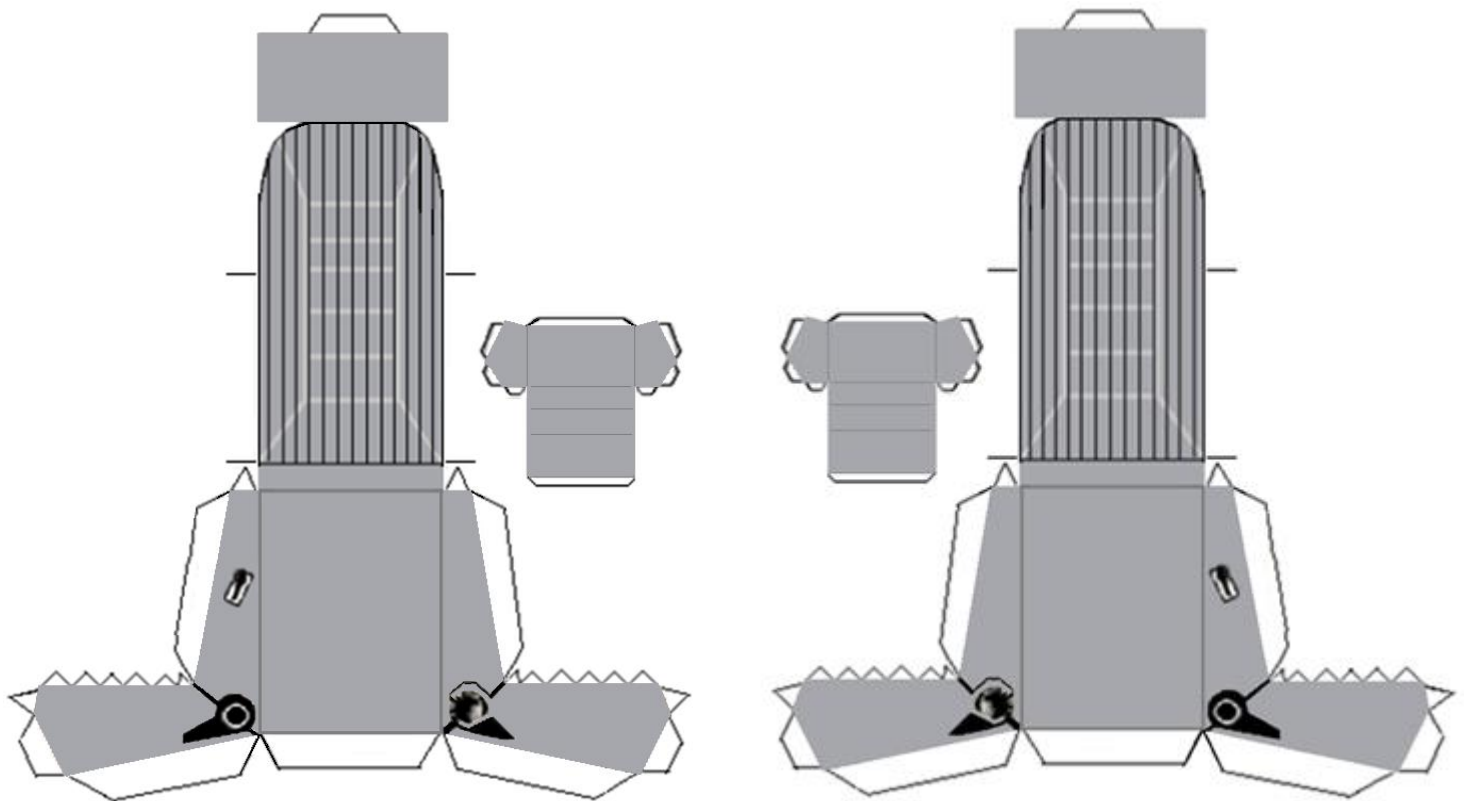
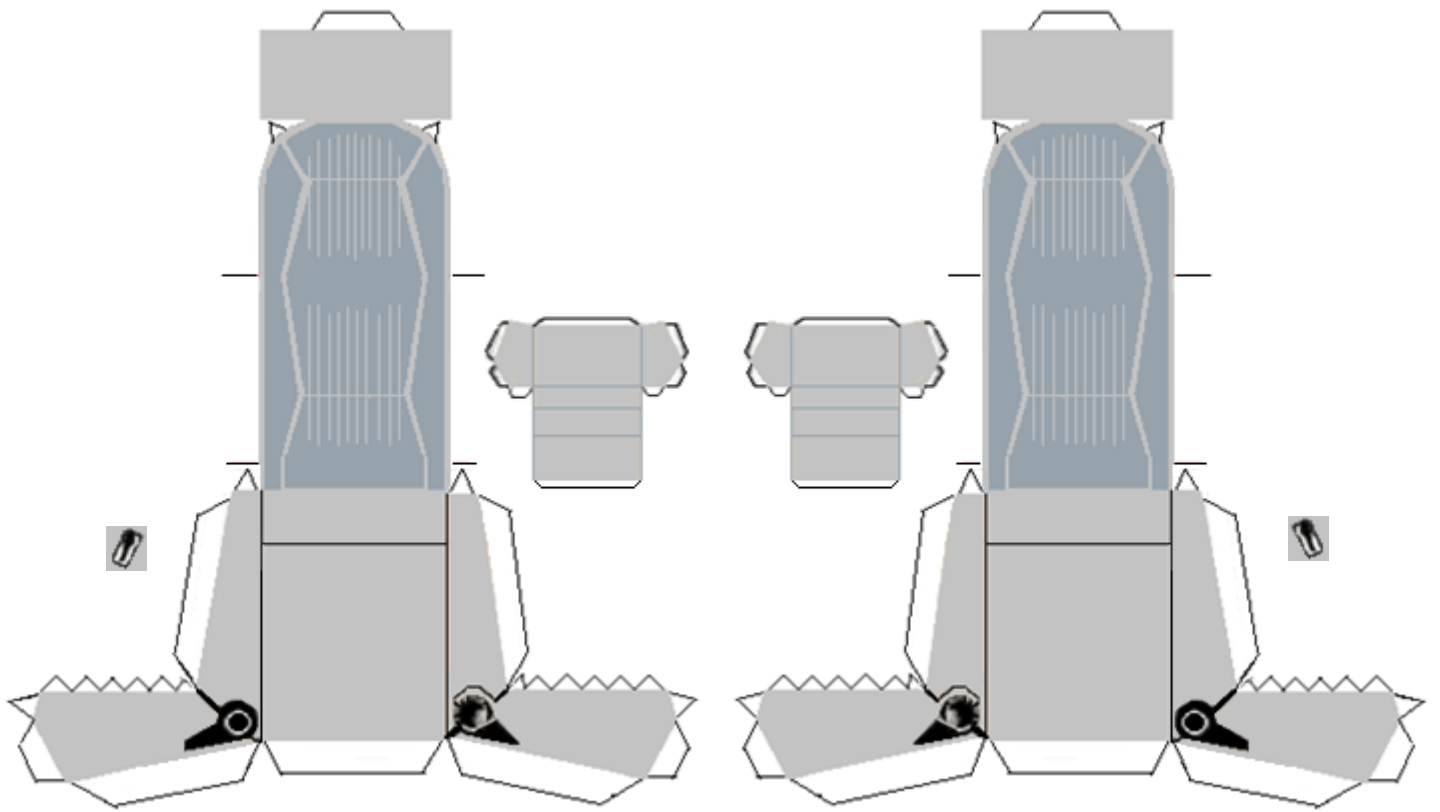

Innenraum

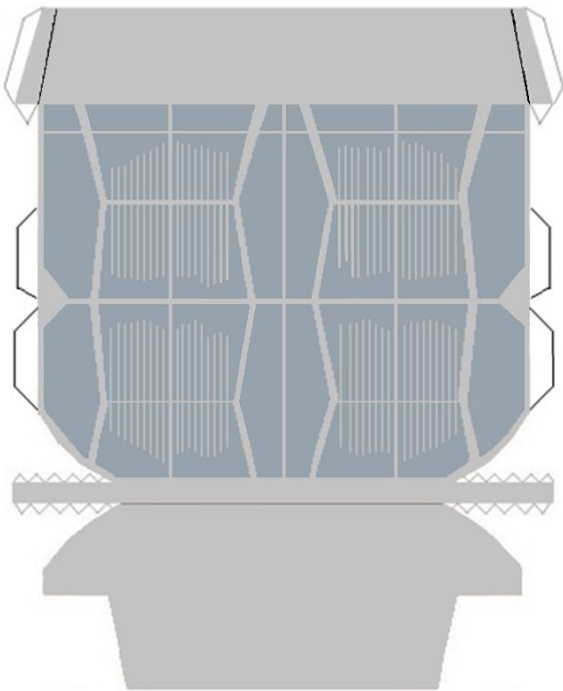
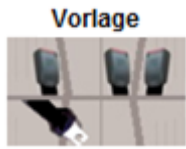
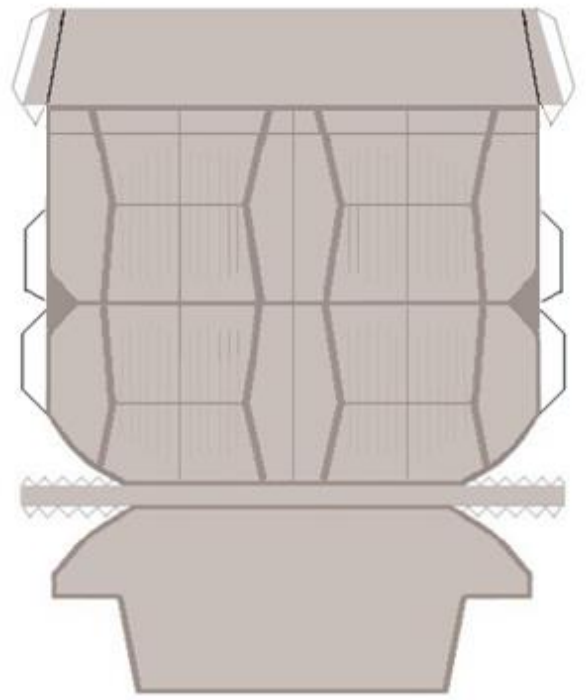
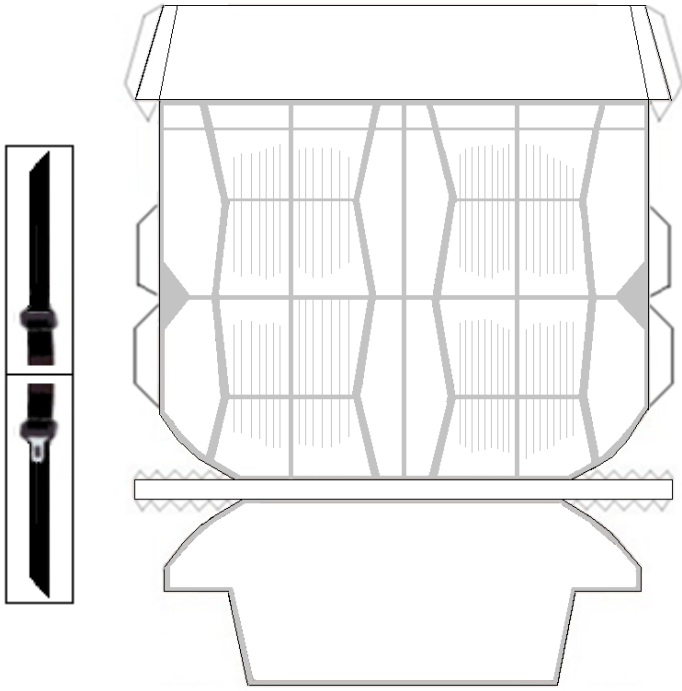

Innenraum Cabrio offen

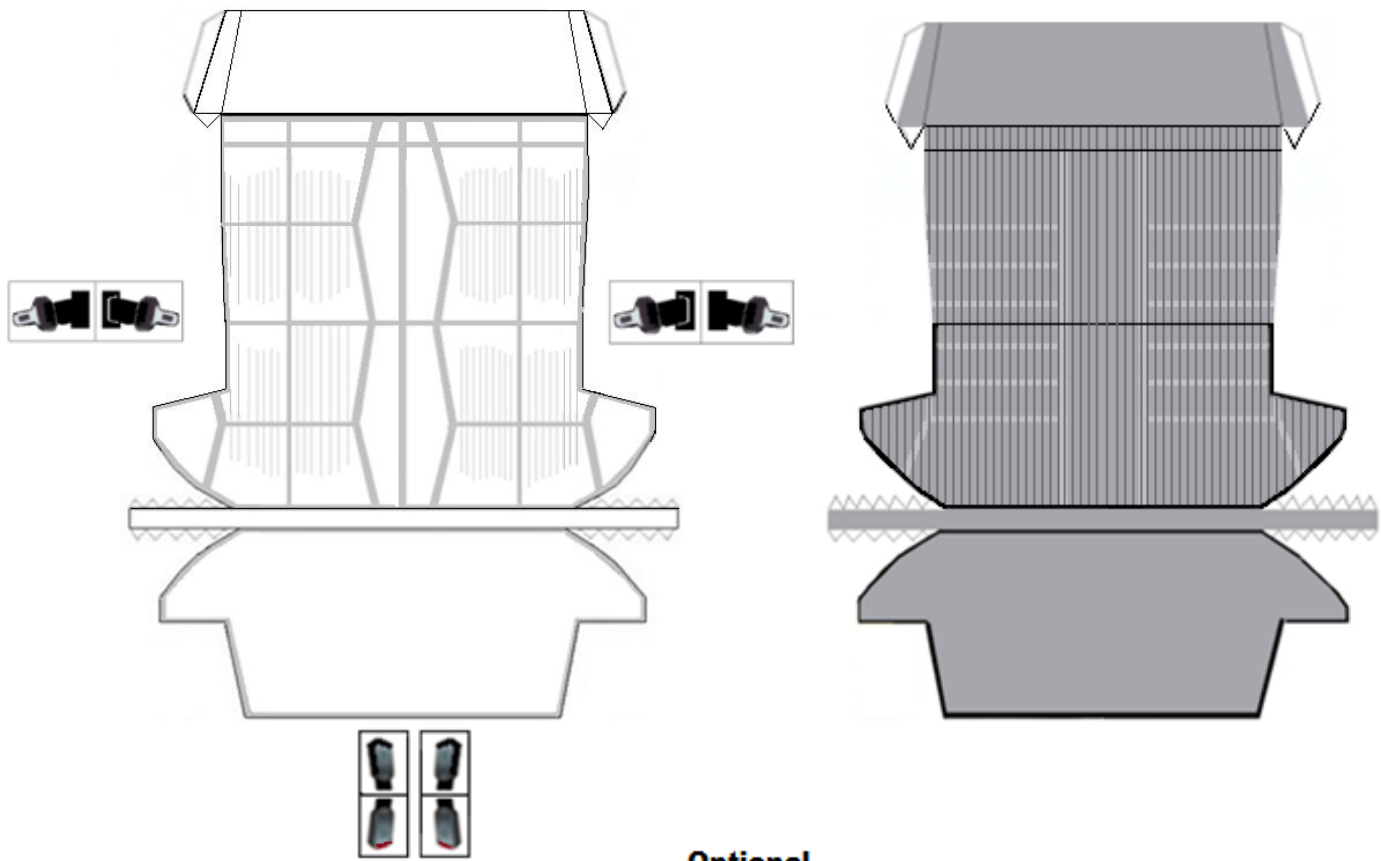

Optional

Dachgepäckträger

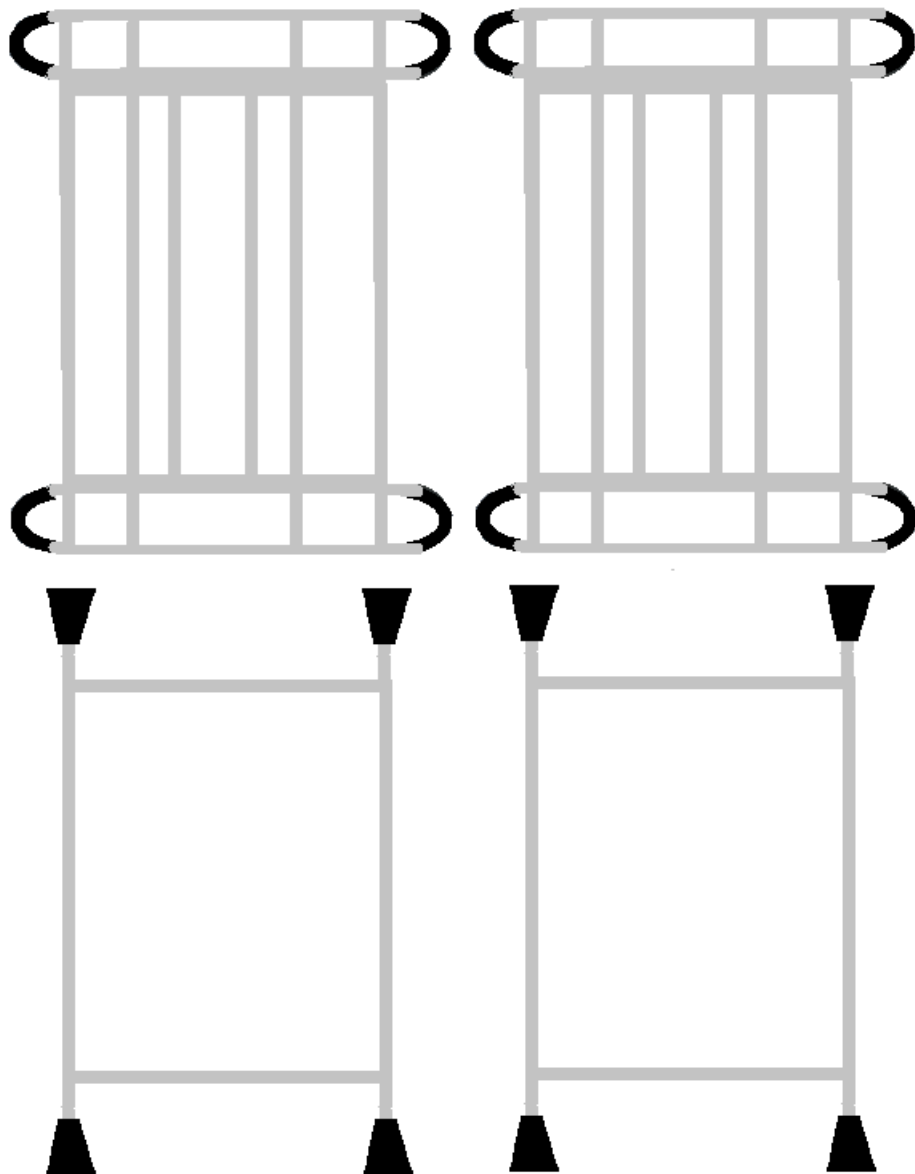

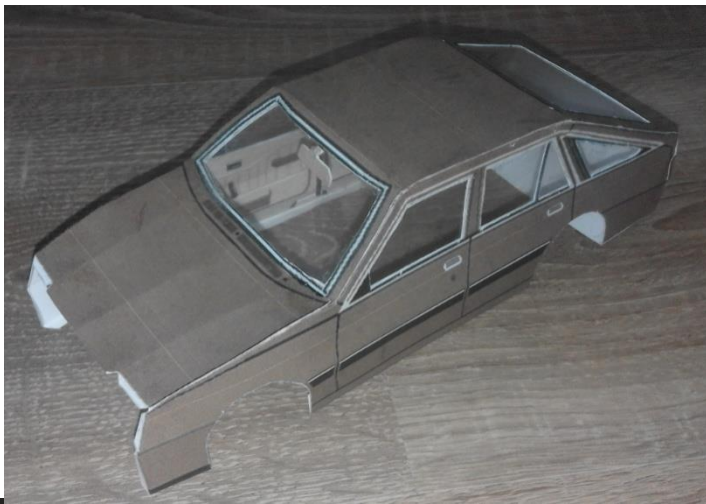

Die Fotos sind von meinem CC das Prinzip ist ja das selbe

Die gewünschten Teile in ein anderes Word Dokument Kopieren

(entweder man bearbeitet die Teile mit einem Zeichenprogramm in der gewünschten Farbe

ZB. Paint und fügt sie dann in Word ein oder man mahlt sie nach dem Drucken mit Filzstiften aus)

Hier eine kleine Beschreibung (aus dem Netz)

Für schwarze Teile wie Räder oder Stosstangen hab ich für die Klebekanten einen schwarzen Eding / Filzstift genommen da sieht mann das weiße Papier durch
zum ritzen der Kanten habe ich ein kleines Teppichmesser genommen (nicht aufdrücken)
Kleber habe ich Klebestift für Papier und Uhu Alleskleber verwendet

Hinweise zum Zusammenbau

Drucken Sie die Bauteile aus. Am besten eignet sich 160 g/m² schweres Papier. Außerdem benötigen Sie folgende Dinge:

Werkzeuge	Baumaterial
<ul style="list-style-type: none">• Schere• (Stahl-)Lineal• Cuttermesser• Zahnstocher zum Verstreichen von Leim• Klebstoff/Bastelleim	<ul style="list-style-type: none">• Optional ein Stück Graupappe, oder besser Finnplatte 1mm stark.

Schneiden Sie die Einzelteile möglichst mit dem Cutter aus. Nehmen Sie die Schere nur für Kleinteile, gebogene Stücke und Klebeecken. Beim Anritzen zum Falzen mit der Stecknadel sollten Sie auf die Biegerichtung achten. Bei Biegungen, die eine Außenecke darstellen, ritzen Sie auf der gedruckten Markierung. Bei Innenecken ritzen Sie von der unbedruckten Seite. Um dabei die Linie von der anderen Seite genau zu treffen, können Sie am Anfang und am Ende der aufgedruckten Linie mit der Stecknadel durch das Papier stechen. So haben Sie auf der Rückseite zwei Punkte, die Sie mit einem Lineal verbinden können. Einige Teile werden ohne Klebelasche stumpf verklebt. Verwenden Sie hierzu am besten Bastelleim, da dieser unsichtbar abtrocknet. Optional benötigen Sie Buntstifte oder einen Wassermalkasten, um die Schnittkanten einzufärben.

Viel Spass beim Basteln